



LOW VOLTAGE AC DRIVES

ABB GENERAL PURPOSE DRIVES

ACS580, 0.75 to 500 kW



ENGINEERED
TO OUTFIT

**Get it fast. Use it easily.
Improve your processes.
ACS580 – general purpose
drives you can trust.**

TABLE OF CONTENTS

04–05	The all-compatible ACS580 series
06–07	Easily take full control of your processes to comprehensively manage your plant
08	Typical industries and applications
09	Generic software features of the ABB all-compatible drives
10	General purpose drives for food and beverage
11	Cooling and refrigeration in food and beverage
12	Pumping in food and beverage
13	Ventilation in agriculture: Livestock and poultry
14	Complete offering, from wall-mounted drives to cabinet installations
16–17	ACS580-01, all-in-one drive for wall mounting
18	ACS580-04, high power drive module for cabinet builders
20–21	ACS580-07, effortless process automation in a ready-made cabinet
22	Standard interface and extensions for plug-in connectivity
23	How to select a drive?
24	ACS580 technical data
25–27	Ratings, types and voltages
28–29	Dimensions
30–31	Cooling and fuses
32	Circuit breakers
33	Sine filters
34–35	du/dt filters
36–37	EMC – electromagnetic compatibility
38–39	Harmonic mitigation
40	Easiness on a whole new level
42	Control panel options and mounting kits
43	Door mounting and daisy chaining
44–45	Digital connectivity for drives and motors
46	ABB Access
47	Drive Composer 3 with ACS580
48–49	ABB Ability™ Digital Powertrain
50	ABB GoSelect web-based tool
51	ABB Drives Software Tools subscriptions
53	ABB drives and OPC UA
54–55	Communication and I/O options
56–57	Commissioning, programming and customization tools
58–59	Safety options
60–61	Thermistor protection I/O option
62	Environmental Product Declarations
63	ABB AC drives comply with the EU Ecodesign requirements
65	ACS580 drives are compatible with the wide ABB product offering
66	Choose the right motor for your application
67	Synchronous reluctance motors
68–69	Selection guide, IE5 synchronous reluctance motors
70–73	Summary of drive ordering codes
74	ABB Motion Services
75	A lifetime of peak performance

THE ALL-COMPATIBLE ACS580 SERIES

Effortless process automation

The ACS580 is an all-compatible ABB general purpose drive, offered in a range of wall-mounted drives, drive modules and cabinet-built drives. It turns complicated to simple and controls processes productively and efficiently.

One product, many applications

ACS580 drives include all the essential components for typical industrial applications, with a scalable offering from 0.75 kW to 500 kW. The drive is ready to control compressors, conveyors, mixers, pumps and fans, as well as many other variable and constant torque applications. The all-compatible drives family ensures that you will always find the best drive for your needs. These drives share a similar user interface and PC tools, making using and learning them fast and easy.

The drive controls a wide range of applications in different industries, and yet it requires very little setting up or commissioning.

Reliability and consistent high quality

ACS580 drives are designed for customers who value high quality and robustness in their applications. The product features, such as coated boards and compact IP55 enclosure, make the ACS580 suitable for harsh conditions also. Additionally, all ACS580 drives are tested at maximum temperature and with nominal loads. The tests include performance and all protective functions.

Easier than ever before

ACS580 drives have all the essential features built-in reducing the commissioning and set-up time. The assistant control panel with multiple language choices is standard in ACS580 drives. Users can also upgrade to an optional Bluetooth control panel for wireless commissioning and monitoring. Primary settings and application control macros ensure quick product setup.

Instant availability

ACS580 products are available from central stocks around the world for immediate delivery up to 500 kW. The product is also widely available from ABB distributors globally.

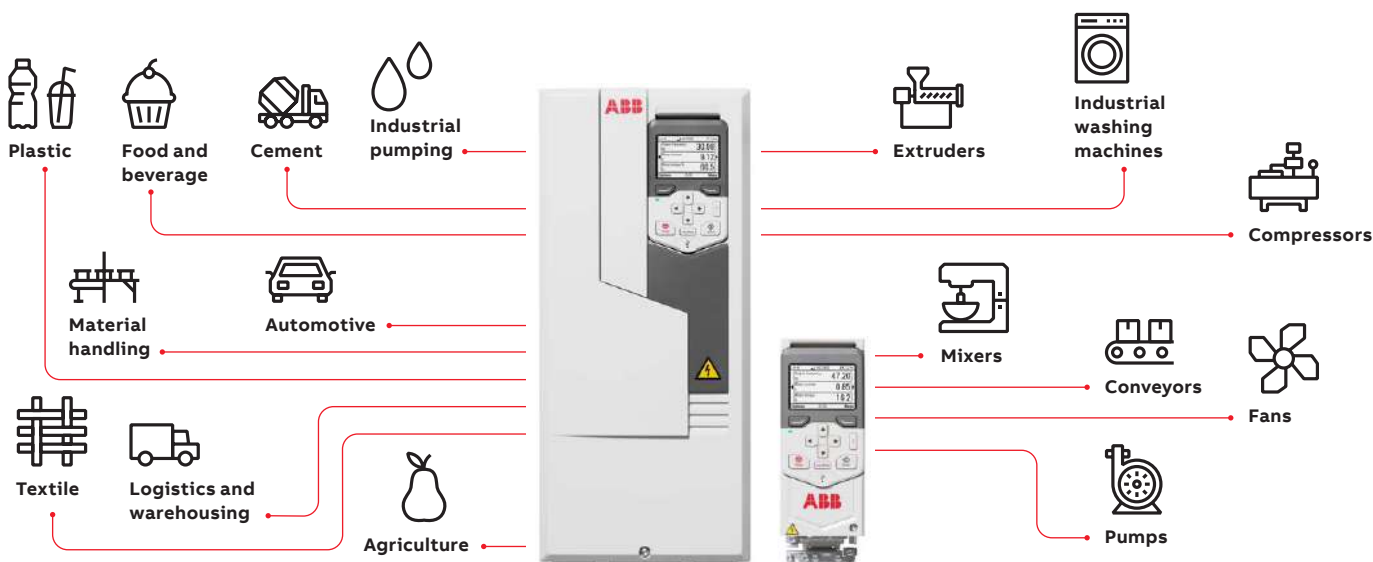



EASILY TAKE FULL CONTROL OF YOUR PROCESSES TO COMPREHENSIVELY MANAGE YOUR PLANT

ACS580 drives are equipped with built-in features that simplify ordering and delivery, and reduce commissioning costs. Everything is provided in a single, compact and ready-to-use package for you to take full control of your processes.



Start-up and maintenance tool

Drive Composer PC tool for startup, configuration, monitoring and process tuning. The PC tool is connected to the drive's control panel via a USB interface.

Simple to select, install and use

Built-in features such as an EMC filter, choke, a Modbus RTU fieldbus interface and Safe Torque Off functionality simplify drive selection, installation and use.



Simplicity at your fingertips as standard

The control panel's straightforward primary settings menu with assistants help you set up the drive quickly and effectively.

Boosting energy efficiency

Energy efficiency information is available in the energy optimizer feature to help you optimize your processes. The energy optimizer feature operates both in scalar and vector control modes, ensuring maximum torque per ampere and reducing energy drawn from the supply. You can follow the saved energy, CO₂ emissions or money, and see how fast the drive brings you a return on investment.

Scalable performance

The ACS580 is a perfect match not only for energy-aware applications, but also for applications where sophisticated speed and torque control are needed.

Powerful, rugged and robust ACS580 drives ensure ease of use, scalability and quality. A wide power range up to 355 kW and various mounting options and enclosure classes (IP21, IP55, and IP66) ensure you will find a drive for your installation and environment needs.



Effortless automation and productivity for your success



Communication with all major automation networks

Optional fieldbus adapters enable connectivity with all major industrial automation networks.



Reliable, integrated safety

The ATEX-certified thermistor protection module, Ex II (2) GD, CPTC-02 provides enhanced process safety and easy, simplified installation.



Adaptive programming

Adaptive programming is ideal for creating simple programs for various applications to further optimize the process control. It does not require expertise in programming.

Designed for maximum reliability

Design features such as coated circuit boards, minimized airflow through the control board section, and earth fault protection make the ACS580 a safe choice for multiple applications.









The Drivetune mobile app

is a powerful tool for drive users to manage drives remotely using a smartphone or other mobile device.

ABB Access you can unlock all aspects of your drives, motors or PLCs, from one central location by scanning the drive's QR code.

TYPICAL INDUSTRIES AND APPLICATIONS

ACS580 drives improve process performance, increase productivity, reduce external components and ensure machine and personnel safety.

Industry	Application	Customer benefits
Food and beverage 	Blowers, centrifuges, compressors, conveyors, fans, mills, pumps, separators, mixers, dryers, pelletizers	<ul style="list-style-type: none"> Accurate control of the process increases the speed of food production while saving energy and improving work safety. Precise speed and torque control increases production uptime even when the load varies. Increased starting torque with boost function allows the same drive series to be used in different applications in the manufacturing plant. Safe Torque Off (SIL 3) function ensures machine and personnel safety. The easy-to-use control panel with multiple languages and robust design reduce the time needed for maintenance. The ATEX-certified thermistor protection module, Ex II (2) GD meets the safety requirements even in dusty environments. Cavitation detection and control helps prevent quality issues while protecting pump impellers.
Rubber and plastics 	Extruders, injection molding machines, pumps	<ul style="list-style-type: none"> Smooth acceleration to prevent breaking the web of plastic film. The scalable all-compatible platform allows easy process and component optimization with different drive types that share the same user interface and tools. Wide range of supported fieldbus protocols for easy PLC integration.
Material handling 	Conveyors	<ul style="list-style-type: none"> Accurate and precise speed and torque control increase production uptime even when the load varies. Safe Torque Off (SIL 3) function ensures machine and personnel safety. Minimized downtime with robust and reliable design. DC or AC choke to mitigate harmonics. External +24 V supply to keep the communication up when the mains supply is disconnected. Standstill autophasing for motor ID-run to do identification run without backward movements.
Textile 	Bleaching machines, compressors, conveyors, industrial washing machines, extruders, fans, jet dyeing machines, pumps, stenter machines, stretchers, winders	<ul style="list-style-type: none"> Precise speed or torque control for high stretching accuracy and better quality of the end product. Adjustable torque limit to prevent damage to mechanical equipment. Adjustable acceleration/deceleration ramps to improve pump control. Real-time clock and timed functions for process optimization. Increased productivity and faster payback times with multiple setups, allowing production of two different products. Built-in counters for additional energy savings and preventive maintenance.
Sawmill 	Chippers, conveyors, feeders, dryers, pickers, drying kilns	<ul style="list-style-type: none"> IP55/UL Type 12 available up to 250 kW for harsh environments. Cabinet-built drive IP54 up to 500 kW. Safe Torque Off (SIL 3) function ensures machine and personnel safety. External +24 V supply to keep the communications "alive" when the mains supply is turned off. ATEX-certified thermistor protection module, Ex II (2) GD.
Industrial pumping 	Pump stations	<ul style="list-style-type: none"> Additional energy savings with energy optimizer function. Adjustable acceleration/deceleration ramps to improve pump control. Minimized downtime with robust and reliable design. ABB's extensive product and service offering for comprehensive process optimization. Cavitation detection and control protects pump impellers from its damaging effects.
Agriculture 	Fans, irrigators, pumps, sorters	<ul style="list-style-type: none"> IP55/UL 12 available up to 250 kW harsh environments. Wall-mounted power range up to 250 kW. Drive modules and cabinet-built drives up to 500 kW.
Chemical, Oil and Gas 	Auxiliary applications like fans or pumps	<ul style="list-style-type: none"> ATEX-certified thermistor protection module, Ex II (2) GD. Increased productivity and faster payback times. Enhanced quality of end products with smooth control of the motor and process. Safe Torque Off (SIL 3) function ensures machine and personnel safety. Wide range of fieldbus networks supported, including PROFIBUS and PROFINET IO. Available up to 250 kW in a high enclosure rating IP55 / UL Type 12 for harsh environments where corrosive gases exist. The robust design of the drive reduces mechanical stress, lowering maintenance costs and ensuring high production quality.
Cooling and refrigeration 	Compressors, fans, pumps	<ul style="list-style-type: none"> Wall-mounted drives up to 355 kW rating. Cooling compressor control features. Flange mounting to optimize cabinet size and heating.

GENERIC SOFTWARE FEATURES OF THE ABB ALL-COMPATIBLE DRIVES

The all-compatible drives platform offers features that make drive integration, commissioning, operation and diagnostics easier than ever before.

Startup assistant allows first-time users to quickly customize the drive according to their needs. Complemented by a built-in help function to make parameter-by-parameter setting easy.

Motor control is implemented in scalar and vector modes for induction, permanent magnet and synchronous reluctance or permanent magnet assisted synchronous reluctance motors. Motor protection features like thermal and overload protection are also established.

The energy optimizer feature optimizes the motor flux so that motor energy consumption and noise level are reduced when operating below the nominal load. The total efficiency can be improved by 1...20% depending on load torque and speed.

Energy counter monitors used and saved energy and displays it in kWh, currency or CO₂ emissions, to know how much exactly was saved.

Drive safety and protection features include overcurrent, DC over- and undervoltage, drive overheating and short circuit protection, motor phase loss and supply phase loss detection, local control loss detection and many more.

People and machine safety is ensured with drive-based Safe-Torque-Off feature, also allowing to conduct maintenance on the mechanical parts of equipment without shutting it down.

Diagnostic assistant helps in locating the cause of any disturbance to the drive, and suggests possible remedies. This reduces downtime by making repairs or adjustments effortless.

A built-in process PID/loop controller makes the drive a self-governing unit that requires no external logic input from the control room but only an external process measurement.

Backup and restore feature makes automatic and manual backups of the drive settings to the assistant panel. A backup can be restored to another drive.

Adaptive programming provides extra flexibility by offering easy alternative for simple programming needs. Download Drive Composer entry for free to start writing your application.

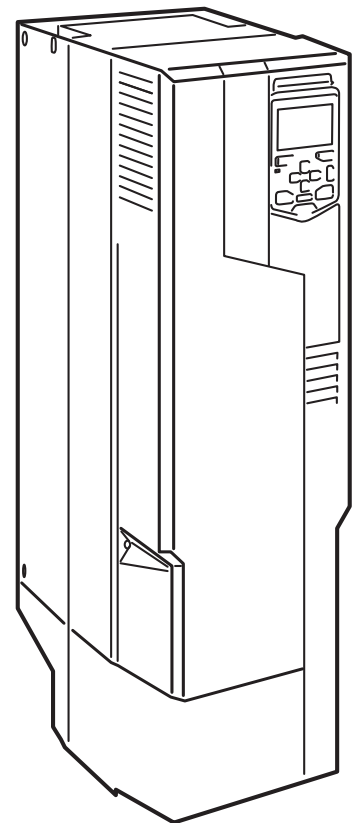

GENERAL PURPOSE DRIVES FOR FOOD AND BEVERAGE

ABB has strong domain expertise in the food and beverage industry and its many subsegments. As part of ABB’s general purpose drives family, the ACS580 is well suited to support a wide range of applications in the food and beverage subsegments.

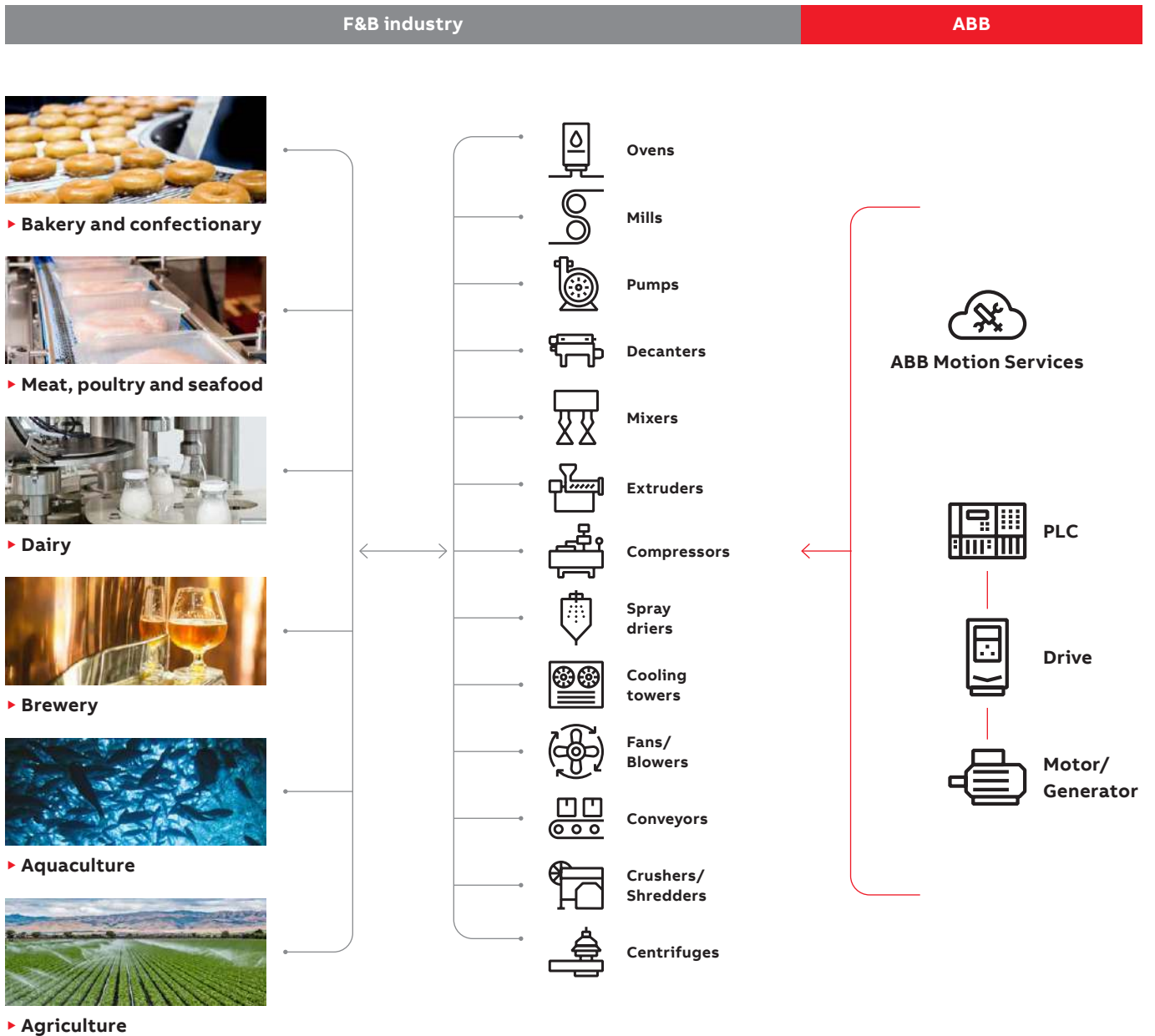

To help our customers to be more effective, we offer a built-in software package for the ACS580 which is dedicated to the food and beverage industry. The software consists

of two different parts, which will improve your processes by utilizing segment-specific functions for cooling compressor control or cavitation detection and control.

COOLING AND REFRIGERATION IN FOOD AND BEVERAGE

Food and beverage is the most significant segment for industrial refrigeration installations. From bakery to meat, dairy, fruit and vegetables, all require refrigeration across the entire cold chain which includes food processing, cold storage, logistic centers and transportation.

Wall-mounted drives up to 355 kW

Combining best-in-class drive technology with software for cooling compressors, up to 355 kW wall mounted with flange cooling options.

Cooling compressor macro

Sets typical parameter values for cooling compressor application and makes it easier to commission the drive.

Multi compressor control

Controlling more than one compressor with one drive, when needed, by changing all the relevant parameters and settings automatically.

Pressure to temperature conversion

Internal scaling is based on refrigerant gases, A2L & A3 gases. The system then automatically adjusts the cooling by using the built-in PID controller.

Short cycle protection

Provides time delays in order to limit the number of starts to avoid damages from repetitive rapid-starting cycles.

**Built-in
intelligence**



Reliable

Our high-quality package solution, based on our deep F&B domain expertise, includes reliable drives, motors and PLCs that help prevent unplanned downtime and other process risks.

Energy efficiency

Cooling systems are the biggest energy consumers in food processing plants. The use of VSDs in cooling compressors will provide average energy savings of 20-40% compared to running in direct on line (DOL) mode.

Easy to use

The user friendly interface and all compatible drive offering brings simplicity and time savings.

Flexible

By supporting all major Fieldbus protocols, wide I/O capacities and adaptive programming features, the ACS580 gives you freedom to design different kinds of control system topologies.

PUMPING IN FOOD AND BEVERAGE

A majority of the pump applications in food and beverage benefit from using a drive. The drive matches the pump-flow-rate with the actual demand, while saving energy and optimizing the production process.

The drive controls the pump-flow-rate by utilizing PID control and feedback from the sensor. This functionality controls the level, pressure, flow or temperature automatically.

Application example:

Level control of a beverage tank

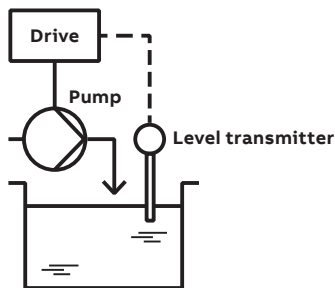

Food and beverage software for ACS580 Cavitation control

Cavitation is caused by local pressure changes in a liquid, creating vapor bubbles that can damage the pump and process when the vapor bubbles implode.

In addition, cavitation can also cause unplanned downtime, production losses and even harm the end-product.



Quality in end-product

Cavitation control helps to avoid shock waves in the liquid. This may lead to poor product quality and lost revenues.

Lower total cost of ownership

Cavitation control eliminates the need for external sensors and reduces maintenance.

The cavitation control feature enables reliable pump operations and increases productivity in the food and beverage industry.

VENTILATION IN AGRICULTURE: LIVESTOCK AND POULTRY

ABB's agricultural expertise and the ACS580 deliver reliable ventilation conditions for your animals and increase overall productivity.

Robustness

- A conformal coating and IP55 option for harsh environment conditions
- Auto-derate option to avoid unwanted tripping of your applications like "oxygen supply fan"
- Built-in choke to reduce mains distortion

Animal welfare

- Optimal ventilation conditions ensure your animal's health and safety

Accessibility and flexibility

- Local/Remote control options
- Bluetooth panel option to connect your drive via your smart phone
- Long motor cable length

Cost savings

- Reducing fan speed via a drive, positively affects energy efficiency which lowers operating costs

Ammonia resistance for the complete drive

Ammonia, which can be found in critical amounts in barns, has a corrosive effect on variable speed drives. The ACS580 offers resistance to corrosive gases, including ammonia, not only for the control boards but also for the entire drive - , making the IP55 and IP66 variants the perfect choice for food and beverage and agriculture applications. This robust design prevents unplanned downtimes while providing an extended lifetime.

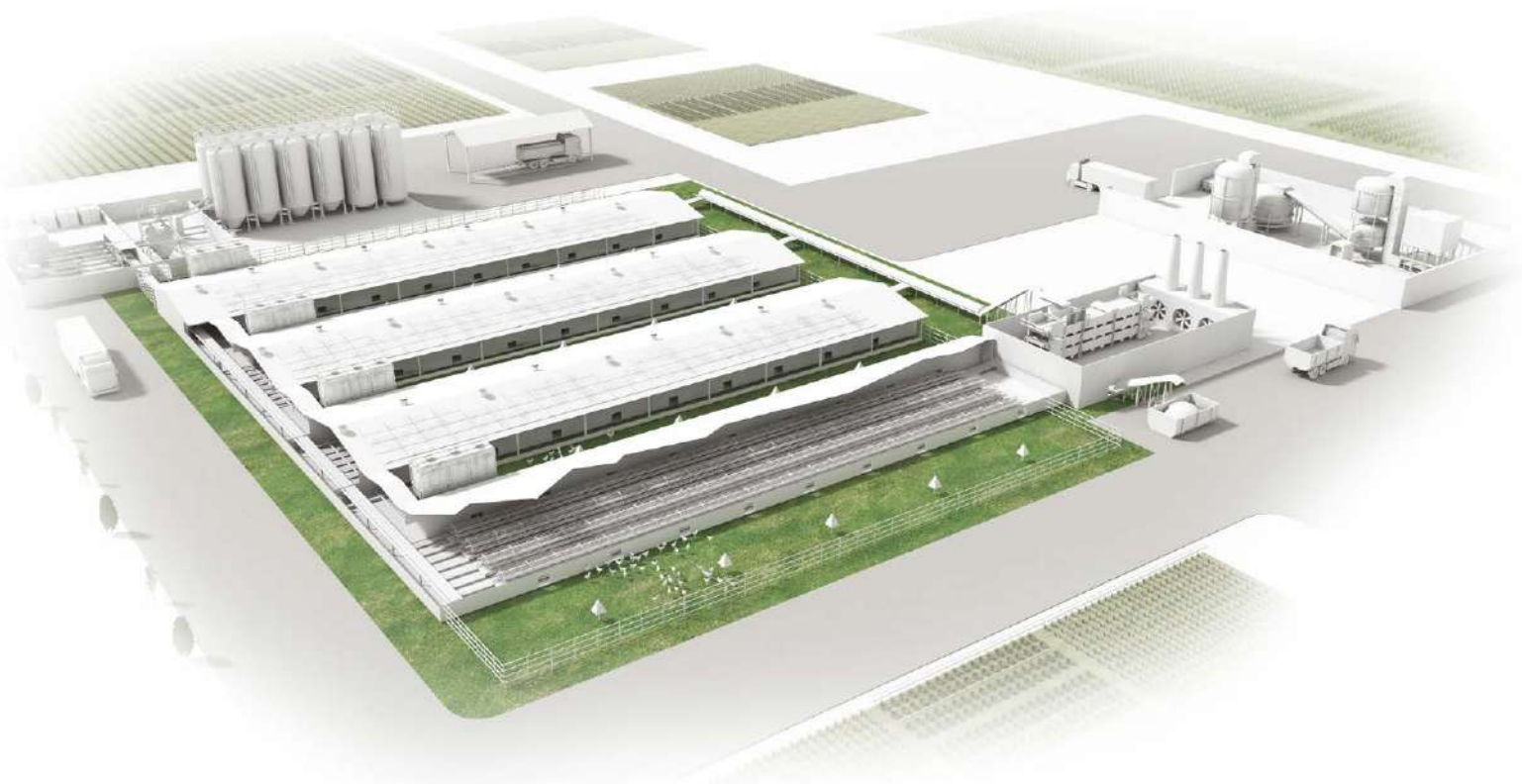

COMPLETE ACS580 DRIVES OFFERING, FROM WALL-MOUNTED UNITS TO CABINET INSTALLATIONS

Powerful, rugged and robust ACS580 drives ensure ease of use, scalability and quality. A wide power range and various mounting options and enclosure classes ensure you will find a drive for your installation and environment needs.

01 Wall-mounted
ACS580-01 drive

02 Drive module
ACS580-04

03 Cabinet-built
ACS580-07 drive

ACS580-01 wall-mounted drives

Wall-mounted drives are available in IP21/UL Type 1, IP55/UL Type 12 and IP66/UL Type 4X protection class, power and voltage range from 0.75 to 355 kW for 3-phase 380-480 V, and 0.75 to 75 kW for 3-phase 200 to 240 V.

Side-by-side mounting, flange mounting and horizontal mounting are all available for wall-mounted ACS580 drives.

The ACS580-01 is the drive with all essentials inside including EMC filter and harmonic mitigation, with easy to use assistant control panel.



01

ACS580-04 drive modules for cabinet installations

ACS580 drive modules are perfect for system integrators, cabinet builders, and OEMs who want to optimize cabinet design using ACS580-04 in power range 250-500 kW, without compromising on easy installation, commissioning and maintenance.



02

ACS580-07 cabinet-built drives

Cabinet-built ACS580-07 drives are available in IP21 protection class as standard (UL Type 1) and optional IP42 (UL Type 1 Filtered) or IP54 (UL Type 12) in frame sizes R4 to R11. The drives feature an optimized cooling arrangement and a high-quality, global cabinet design. Available in a power range of 30-500 kW.



03



ACS580-01

All-in-one drive for wall mounting



- Take advantage of flexible, cabinet-free installation
- Save space, increase safety and reduce overall costs
- Maintain productivity in harsh conditions
- Minimize downtime and optimize operation

The ACS580-01 can be installed in normal equipment rooms, or even dusty and wet environments, thanks to the drive's wall mountable construction in both IP21 and IP55 protection classes. The robust and protective design ensures that no additional enclosures or components, such as filters and

fans, are needed. The drives provide smaller capital expenses by avoiding or advancing maintenance of external components, which in turn improves the reliability of the drive and the process.

High protection for operation in harsh environments

The IP55 ACS580-01 drive is designed for applications in dusty, moist and other harsh environments, and offers C4 corrosion resistance. Similar in size to the compact IP21 drive, it offers significant installation, engineering and material cost advantages.

The IP66 drive further extends the protection class to work in any environment, indoor or outdoor, in extreme hot or cold, and in wash-down (or dry) zones.

These units can be installed directly on the wall next to the motor, for installation simplicity. The robust design ensures that no additional enclosures or components, such as dust filters and fans, are needed.



Option code	Description
+B056	IP55/UL Type 12 Unit
+B063	IP66/UL TYPE 4X UNIT

Ready made accessories for simplified cabinet assembly

Installing ACS580-01 drives into Rittal VX25 cabinets is easy with mechanical and electrical accessory kits. The ready made accessories will save time in design work and reduce the building time to ensure faster cabinet delivery.

This will enable machine builders, system integrators and panel builders to built drive packages using their own cabinet design with ABB technology. For more information, please see manual supplement [3AXD50000523191](#).

Main disconnect switch for increased safety

The main disconnect switch option allows to disconnect the drive from the main supply when needed. This prewired main disconnect switch option saves time, money and space as it is integrated in the drive. There is no need to install, external isolation devices to the supply side of the drive. The option improves safety as it is always visible, when operating on the drive.

An auxiliary contact allows signaling the switch position to a PLC to avoid unnecessary alarms. The switch can be padlocked to the open position to disable drive operation during e.g. maintenance.

The ACS580 IP55/UL Type 12 units can be ordered with an integrated main switch and/or EMC C1 filter (R1-R5). Having the EMC C1 filter embedded to the drive, there is no need to order, install and test it separately. The integrated filter is already tested with the drive and prewired so there is no need for additional cabling.



Option code	Description
+B056	IP55/UL Type 12 unit (R1-R9)
+F278	Integrated main switch (R1-R5)
+E223	Integrated C1 filter (R1-R5)
+F316	Integrated main switch and C1 filter (R1-R5)

IP20 option without a conduit box for cabinet installations

The option removes the conduit box from ACS580-01 frames R5-R9, making it easier to install the drive in cabinets with limited space. These IP20 units optimize the installation from cost and dimensioning point of view, and reduce waste. The option is also compatible with the flange mounting option for ACS580-01 frames R5-R9.



Option code	Description
+P944	Conduit box removal (R5-R9)

Flange mounting

The ACS580-01 wall-mounted drive offers flange mounting as an option, separating the control electronics from the main circuit cooling airflow, saving space and ensuring optimal cooling. This results in better thermal management in panel installation. The flange mounting option enables smaller cabinets to be used as the backside of the drive is installed outside of the cabinet. This mounting method minimizes the need for cabinet cooling and decreases the installation cost.

The option is compatible only with the standard IP21 units. It maintains the protection class of IP55 on the backside of the drive, while the front side of the drive is IP20. The option is also available as a loose item with an MRP code. If necessary, the conduit box can be removed from the frames R5-R9.



Option code	Description
+C135	Flange mounting
+P944	Conduit box removal (R5-R9)

ACS580-04

High power drive module for cabinet builders



- Compact drive module for cabinet mounting, saving floor space
- High power in compact size
- Easy installation, commissioning and maintenance with pedestal on wheels and ramp

ACS580 drive modules have been optimized for assembly into the customer's own cabinets to ensure high quality and compact installation at minimal cost.

Specifically designed for cabinet builders and systems integrators. The module variant is as standard IP00 but available as IP20 with additional finger shrouds. For optimized cabinet usage, features include power input connections on the top of the module and power output on the bottom. The control unit can be installed inside or outside of the module, enabling free location of input/output terminals. The external control unit can be mounted separately.



Option code	Description
+B051	IP20 Finger shrouds for modules
+H370	Full-size cable connection terminals for input power cables
+0H371	Drive module without full-size output cable connection terminals
+0H354	No pedestal
+0P919	No cabinet installation ramp
+P906	External control unit



ACS580-07

Effortless process automation in a ready-made cabinet



- Easy to order with ready made standard design and variety of options
- Easy to maintain with easily accessible and smartly positioned components
- EMC and thermal tested with certified results
- Adaptable to harsh environments with unique cooling system

The ACS580-07 drives range from 30-500 kW and are easy to use and maintain, and quickly available from the factory. An EMC filter, chokes, assistant control panel, Modbus RTU, STO and installation tools are included as standard, and in addition there are several options available to further fulfill your needs.

Smartly positioned fans and filters ensure the longevity of the drive and its components. When it is time to do maintenance, the necessary components are in easily accessible locations. The simple and robust design ensures reliable operation even in harsh environments.

The thermal properties are tested according to IEC 61800-5-1:2007 and UL61800-5-1 1st ed. 2012 standards to ensure the environment and operators stay safe in all conditions. Be it a premature fan failure or clogged environmental filters to restrict cooling, the tests verify that the equipment is self-protecting it.

Option code	Description
+B054	IP42 for cabinet built drives
+B055	IP54 for cabinet built drives

Empty cabinet options are available to the customers who need additional space for installation of auxiliary devices such as PLCs, relays, filters, brake resistors or by-pass systems. For more information, please contact your local ABB representative.

Factory acceptance test (FAT)

To ensure that the drive solutions meet the specifications and the customer expectations, ABB offers to have a factory acceptance test (FAT) in our drives factory. Remote FAT or visual inspection is possible via online services.

A unique cooling system and special arrangement of components ensure the drive units stay cool even in harsh environments with air pollution.

Frame sizes R4-R9

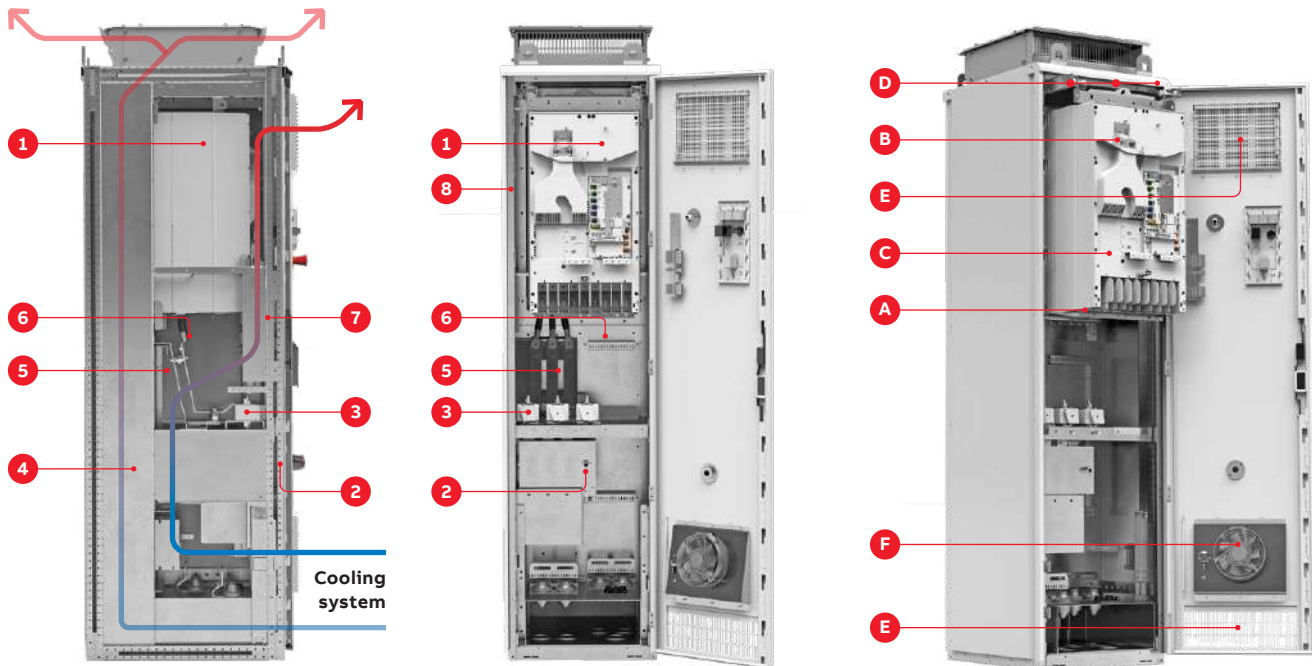

Frame sizes R10-R11

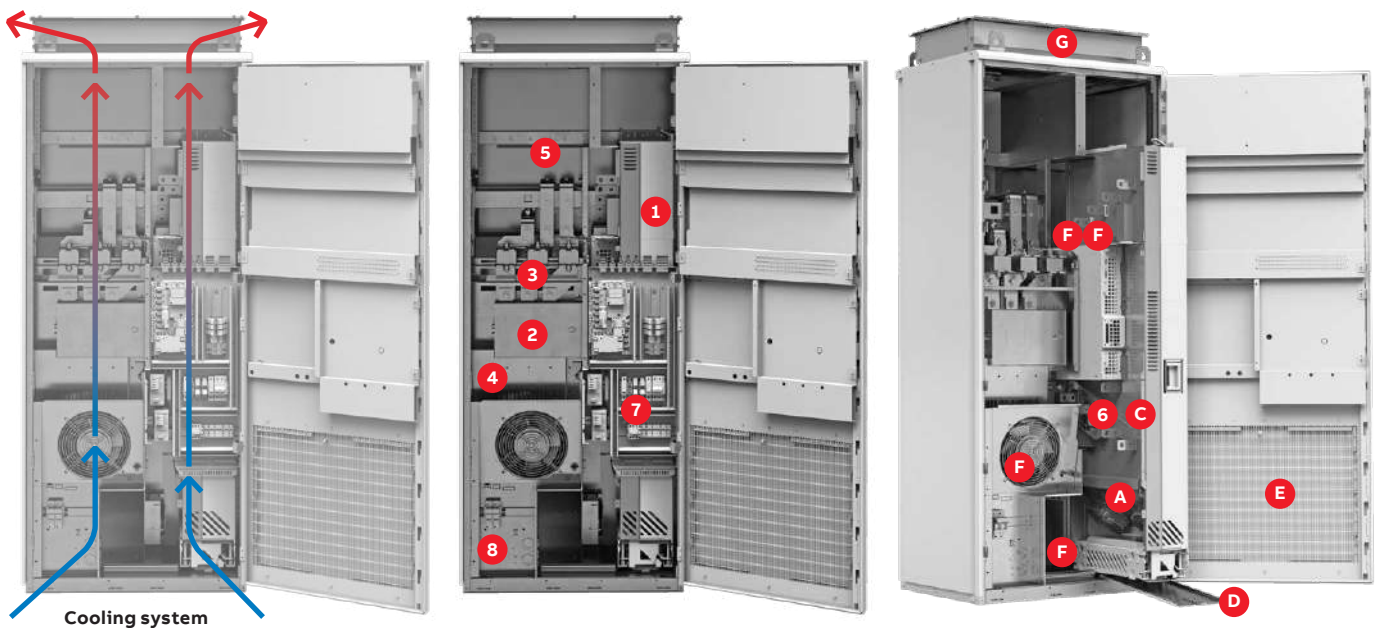

Cabinet components

1. Module
2. Main switch or MCC8, option +F289
3. Fuses
4. Space for optional du/dt filter or cabinet heaters
5. Space for a line contactor option +F250
6. Common mode filter allocation
7. Space for safety, ATEX or external power supply options
8. Space for options +M600...+M605

Maintenance operation components

- A Main fans
- B Auxiliary fans
- C Capacitors (inside the module)
- D Rails and ramp supporting maintenance operation
- E Filters for dust and external components
- F Other supporting fans for R10 and R11
- G Roof top for R10 and R11 (only IP54)

STANDARD INTERFACE AND EXTENSIONS FOR PLUG-IN CONNECTIVITY

ACS580 drives offer a wide range of standard interfaces. In addition, the drive has two option slots that can be used for extensions, including fieldbus adapters and input/output extension modules that allow an external +24 V supply with frame sizes R1 to R5. For frames R6-R11 external +24 V terminals are already integrated on the control board. For further information, please see the ACS580 user manual.

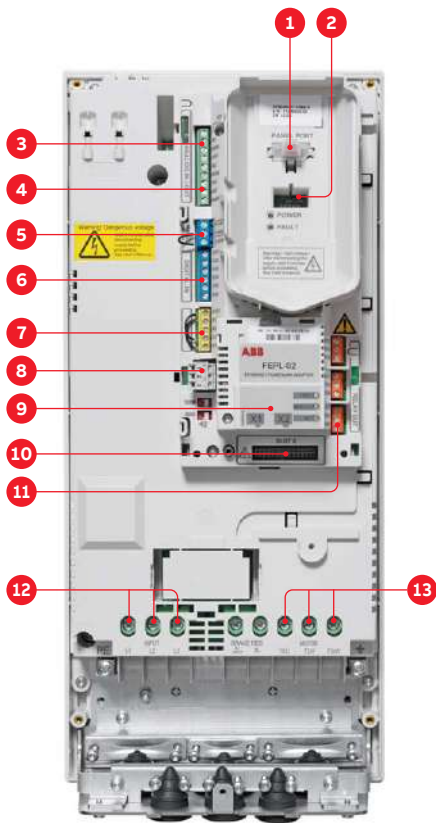

1. Panel port (PC tools, control panel)
2. ABB drive customizer port for programming the drive without mains
3. Analog inputs (2 × AI)
4. Analog outputs (2 × AO)
5. 24 V AC/DC output
6. Digital inputs (6 × DI)
7. Safe Torque Off (STO)
8. Embedded fieldbus
9. Communication options (fieldbuses)
10. I/O extensions
11. Relay outputs (3 × RO)
12. Mains connection
13. Motor connection

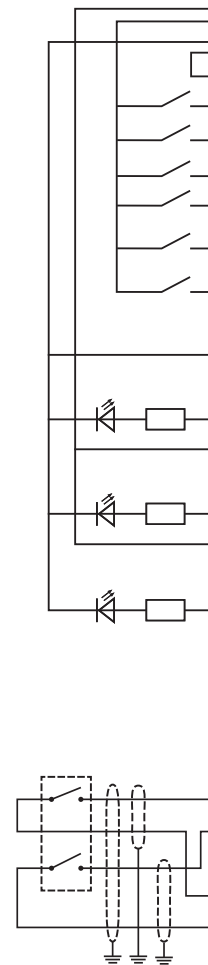
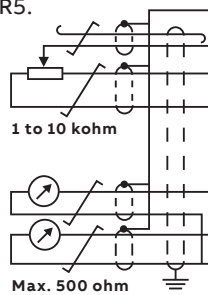

DEFAULT FACTORY I/O CONNECTION DIAGRAM: MACRO ABB STANDARD

Terminal	Meaning	Default macro connections
X1 Reference voltage and analog inputs and outputs		
1	SCR	Signal cable shield (screen)
2	AI1	External frequency reference 1: 0 to 10 V
3	AGND	Analog input circuit common
4	+10 V	Output reference voltage 10 V DC
5	AI2	Not used
6	AGND	Analog input circuit common
7	AO1	Output frequency: 0 to 20 mA
8	AO2	Output current: 0 to 20 mA
9	AGND	Analog output circuit common
X2 & X3 Aux. voltage output and programmable digital inputs		
10	+24 V	Auxiliary voltage output +24 V DC
11	DGND	Auxiliary voltage output common
12	DCOM	Digital input common for all DI
13	DI1	Start/Stop: Activate to start
14	DI2	Fwd/Rev: Activate to reverse rotation direction
15	DI3	Constant speed selection
16	DI4	Constant speed selection
17	DI5	Ramp pair selection: Activate to select second pair
18	DI6	Not used
X6, X7, X8 Relay outputs		
19	RO1C	Ready
20	RO1A	250 V AC/30 V DC 2 A
21	RO1B	
22	RO2C	Running
23	RO2A	250 V AC/30 V DC 2 A
24	RO2B	
25	RO3C	Fault (-1)
26	RO3A	250 V AC/30 V DC 2 A
27	RO3B	
X5 EIA-485 Modbus RTU		
29	B+	Built-in Modbus RTU fieldbus interface
30	A-	
31	DGND	
X4 Safe Torque Off		
34	OUT1	Safe Torque Off. Both circuits must be closed for the drive to start. The circuits are closed with jumper wires in the standard delivery.
35	OUT2	
36	SGND	
37	IN1	
38	IN2	
X10*) 24 V AC/DC		
40	24 V	AC/DC-in. Ext. 24 V AC/DC input to power up the control unit when the main supply is disconnected
41	24 V	AC/DC+in.

*) The terminals 40-41 are integrated only in the frame sizes R6-R11. For the frame sizes R1-R5 I/O options (+L) are needed.

ACS580 TECHNICAL DATA

Mains connection	
Input voltage and output power range	3-phase, UN 200 to 240 V, +10%/-15% ACS580-01: from 0.75 up to 75 kW 3-phase, UN 380 to 480 V, +10%/-15% ACS580-01: from 0.75 up to 355 kW 3-phase, UN 380 to 480 V, +10%/-10% ACS580-04: from 250 up to 500 kW ACS580-07: from 30 up to 500 kW
Frequency	from 47 to 63 Hz
Power factor	$\cos\varphi = 0.98$
Efficiency class (IEC 61800-9-2)	IE2
Motor connection	
Voltage	0 to U_N , 3-phase
Motor control	Scalar and vector control
Torque control	Torque step rise time: <10 ms with nominal torque
Speed control	Static accuracy: 20% of motor nominal slip Dynamic accuracy: 1% seconds with 100% torque step
Maximum recommended motor cable length	R1: 100 m R2: 200 m R3-R11: 300 m
Supported motor types	Asynchronous AC induction motors (IM) Permanent magnet motors (PMSM/IPM, PMSM/SPM) Synchronous reluctance motors (SynRM) Permanent magnet assisted synchronous reluctance motors (PMaSynRM, SynRM2, EC Titanium)
Product compliance	
CE Low Voltage Directive 2014/34/EU, EN 61800-5-1: 2007 Machinery Directive 2006/42/EC, EN 61800-5-2: 2007 EMC Directive 2014/30/EU, EN 61800-3: 2004 + A1: 2012 RoHS directive 2011/65/EU Quality assurance system ISO 9001 and Environmental system ISO 14001 Waste electrical and electronic equipment directive (WEEE) 2002/96/EC RoHS directive 2011/65/EU UL, EAC, RCM, UL, cUL, CMIM TÜV Nord (safety functions) UKCA Ecodesign (EU) 2019/1781	
Harmonics compliance	
Built-in optimized DC/AC choke as standard in ACS580-01 meets the requirements of IEC 61000-3-12:2011.	
EMC compliance	
EMC according to IEC 61800-3:2004 + A1:2012 Class C1 with built-in filter as option for ACS580-01 up to 55 kW Class C2 as standard for ACS580-01 Class C3 as standard for ACS580-04 and ACS580-07	
Inputs and outputs (standard configuration)	
2 analog inputs	Selection of Current/Voltage input mode is user programmable.
Voltage signal	0 (2) to 10 V, R in >200 kΩ
Current signal	0 (4) to 20 mA, R in = 100 Ω
Potentiometer reference value	10 V ±1% max. 20 mA
2 analog outputs	AO1 is user programmable for current or voltage. AO2 current
Voltage signal	0 to 10 V, R load: >100 kΩ
Current signal	0 to 20 mA, R load: <500 Ω
Internal auxiliary voltage	24 V DC ±10%, max. 250 mA
6 digital inputs	12 to 24 V DC, 24 V AC, Connectivity of PTC sensors supported by a single digital input. PNP or NPN connection (5 DIs with NPN connection).
3 relay outputs	Maximum switching voltage 250 V AC/30 V DC Maximum continuous current 2 A rms
Supported thermistors	Any of the analog inputs, or digital input 6, are configurable for PTC with up to 6 sensors. Both analog outputs can be used to feed the PT100, PT1000, KTY83, KTY84 or Ni1000 sensors. For more detailed information please see the ACS580 hardware manual.
Environmental limits	
Transportation and storage temperature	-40 to +70 °C
Operation temperature	ACS580-01: -15 to +55 °C (from +40 to +55 °C with derating), no frost allowed. Type 4X/IP66: -25 to +50 °C with derating. ACS580-04: -15 to +55 °C (from +40 to +55 °C with derating), no frost allowed ACS580-07: 0 to +50 °C (from +40 to +50 °C with derating), no frost allowed
Cooling method	Dry clean air
Altitude	Rated current available at 0 to 1000 m Reduced by 1% per 100 m over 1000 m up to 4000 m
Relative humidity	5 to 95%, no condensation allowed
Degree of protection	ACS580-01: IP21 (UL Type 1) as standard, IP55 (UL Type 12) as option ACS580-04: IP00 (UL Type Open) as standard, IP20 (UL Type 1) as option ACS580-07: IP21 (UL Type 1) as standard, IP42 (UL Type 1 Filtered) and IP54 (UL Type 12) as option
Contamination levels	Operation: IEC 60721-3-3:2019 and ISO9223: ANSI-ISA 71.04 Chemical gases: IEC Class C3, ANSI G2 for IP21 base drive IEC Class C4, ANSI G3/GX up to 2300 Å /30d corrosivity for IP55 drive Solid particles: Class 3S6, no conductive dust allowed Storage: IEC 60721-3-1:2018 Chemical gases: Class 1C2 Solid particles: Class 1S3 (packaging must be Class 2S2, otherwise this is 1S2) Transportation: IEC 60721-3-2:2018 Chemical gases: Class 2C2 Solid particles: Class 2S2
Functional safety	
STO according to EN 61800-5-2:2016, IEC 61508 Parts 1-2:2010, ISO 13849-1:2015, ISO 13849-2:2012, IEC 62061:2021 SIL 3/PL e	
External power supply	
Standard: ACS580-01 frames R6-R9e, ACS580-04 all frames and ACS580-07 all frames	1.5 A at 24 V AC/DC ±10%
With option: ACS580-01 frames R1-R5	1.04 A at 24 V AC/DC ±10%
Communication	
Protocol as standard (EIA-485): Modbus RTU. Protocols available as option: EtherNet/IP, EtherNet POWERLINK, Modbus/TCP, EtherCAT, PROFINET IO, PROFISafe (for STO and SS1-t functions), CANopen, ControlNet, DeviceNet and Profibus DP, CIP Safety.	
Protection functions	
Overvoltage controller Undervoltage controller Motor and motor cable earth-leakage monitoring Motor and motor cable short-circuit protection Motor over temperature protection Output and input switch supervision Motor overload protection Phase-loss detection (both motor and supply) Under load supervision (belt loss detection) Overload supervision Stall protection Loss of control reference	

RATINGS, TYPES AND VOLTAGES

3-phase, $U_N = 230\text{ V}$ (range 200 to 240 V). The power ratings are valid at nominal voltage 230 V (0.75 to 75 kW)

Drive type	Frame size	Nominal ratings		Light-duty use		Heavy-duty use		Maximum output current
		I_N (A)	P_N (kW)	I_{Ld} (A)	P_{Ld} (kW)	I_{Hd} (A)	P_{Hd} (kW)	I_{Max} (A)
ACS580-01-04A7-2	R1	4.7	0.75	4.6	0.75	3.5	0.55	6.3
ACS580-01-06A7-2	R1	6.7	1.1	6.6	1.1	4.6	0.75	8.9
ACS580-01-07A6-2	R1	7.6	1.5	7.5	1.5	6.6	1.1	11.9
ACS580-01-012A-2	R1	12	3	11.8	3	7.5	2.2	19.1
ACS580-01-018A-2	R1	16.9	4	16.7	4	10.6	3	22
ACS580-01-025A-2	R2	24.5	5.5	24.2	5.5	16.7	4	32.7
ACS580-01-032A-2	R2	31.2	7.5	30.8	7.5	24.2	5.5	43.6
ACS580-01-047A-2	R3	46.7	11	46.2	11	30.8	7.5	62.4
ACS580-01-060A-2	R3	60	15	59.4	15	46.2	11	83.2
ACS580-01-076A-2	R4	76	18.5	74.8	18.5	59.4	15	107
ACS580-01-091A-2	R4	91	22	88	22	74.8	18.5	134
ACS580-01-115A-2	R5	115	30	114	30	88	22	158
ACS580-01-144A-2	R6	144	37	143	37	114	30	205
ACS580-01-171A-2	R7	171	45	169	45	143	37	257
ACS580-01-213A-2	R7	213	55	211	55	169	45	304
ACS580-01-276A-2	R8	276	75	273	75	211	55	380

Nominal ratings

I_N	Rated current available continuously without overloadability at 40 °C.
P_N	Typical motor power in no-overload use.

Maximum output current

I_{max}	Maximum output current. Available for 2 seconds at start, then as long as allowed by drive temperature.
-----------	---

Light-overload use

I_{Ld}	Continuous current allowing 110% I_{Ld} for 1 minute every 10 minutes at 40 °C.
P_{Ld}	Typical motor power in light-overload use.

Heavy-duty use

I_{Hd}	Continuous current allowing 150% I_{Hd} for 1 minute every 10 minutes at 40 °C.
P_{Hd}	Typical motor power in heavy-duty use.

The ratings apply for the frames R1 to R9 up to +40 °C in enclosed IP21/IP55.

For derating at high altitudes, temperatures or switching frequencies, see the user's HW manual, document code: 3AXD50000044794.

OVERLOADABILITY AND OUTPUT CURRENT ILLUSTRATION

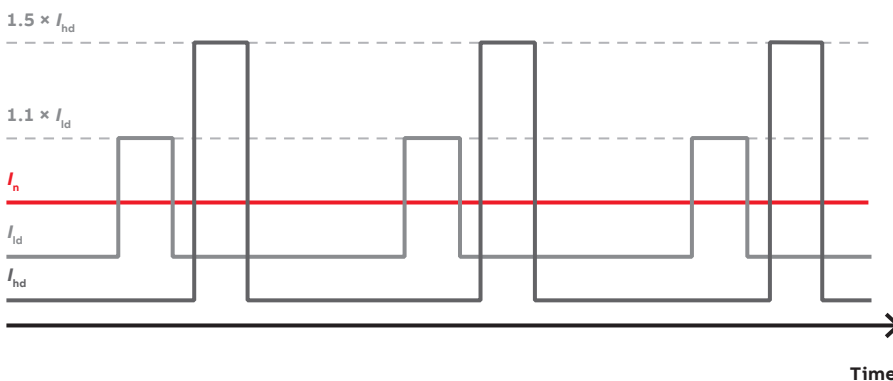

Definition	ACS580
No overload	I_n
110% overload 1 min / 10 minutes	I_{ld}
150% overload 1 min / 10 minutes	I_{hd}

Wall-mounted drives, ACS580-01 (3-phase supply voltage range 380-480 V)														
Frame type	Frame size	3-phase, $U_N = 400\text{ V}$							3-phase, $U_N = 480\text{ V}$					
		Nominal ratings		Light-duty use		Heavy-duty use			Max. output current	Light-duty use		Heavy-duty use		Max. output current
		P_N (kW)	I_N (A)	I_{Ld} (A)	P_{Ld} (kW)	I_{Hd} (A)	P_{Hd} (kW)	I_{max} (A)		I_{Ld} (A)	P_{Ld} (hp)	I_{Hd} (A)	P_{Hd} (hp)	
ACS580-01-02A7-4	R1	0.75	2.6	2.5	0.75	1.8	0.55	3.2	2.1	1	1.6	0.75	2.9	
ACS580-01-03A4-4	R1	1.1	3.3	3.1	1.1	2.6	0.75	4.7	3	1.5	2.1	1	3.8	
ACS580-01-04A1-4	R1	1.5	4	3.8	1.5	3.3	1.1	5.9	3.5	2	3	1.5	5.4	
ACS580-01-05A7-4	R1	2.2	5.6	5.3	2.2	4	1.5	7.2	4.8	3	3.4	2	6.1	
ACS580-01-07A3-4	R1	3	7.2	6.8	3	5.6	2.2	10.1	6	3	4	3	7.2	
ACS580-01-09A5-4	R1	4	9.4	8.9	4	7.2	3	13	7.6	5	4.8	3	8.6	
ACS580-01-12A7-4	R1	5.5	12.6	12	5.5	9.4	4	15.3	12	7.5	7.6	5	13.7	
ACS580-01-018A-4	R2	7.5	17	16.2	7.5	12.6	5.5	22.7	14	10	11	7.5	19.8	
ACS580-01-026A-4	R2	11	25	23.8	11	17	7.5	30.6	23	15	14	10	25.2	
ACS580-01-033A-4	R3	15	32	30.4	15	24.6	11	44.3	27	20	21	15	37.8	
ACS580-01-039A-4	R3	18.5	38	36.1	18.5	31.6	15	56.9	34	25	27	20	48.6	
ACS580-01-046A-4	R3	22	45	42.8	22	37.7	18.5	67.9	44	30	34	25	61.2	
ACS580-01-062A-4	R4	30	62	58	30	44.6	22	81	52	40	40	30	76	
ACS580-01-073A-4	R4	37	73	68.4	37	61	30	109.8	65	50	52	40	104	
ACS580-01-089A-4	R4	45	89	83	45	72	37	129.6	77	60	65	50	117	
ACS580-01-106A-4	R5	55	106	100	55	87	45	156.6	96	75	77	60	148	
ACS580-01-145A-4	R6	75	145	138	75	105	55	178	124	100	96	75	178	
ACS580-01-169A-4	R7	90	169	161	90	145	75	247	156	125	124	100	247	
ACS580-01-206A-4	R7	110	206	196	110	169	90	287	180	150	156	125	287	
ACS580-01-246A-4	R8	132	246	234	132	206	110	350	240	200	180	150	350	
ACS580-01-293A-4	R8	160	293	278	160	246 ^{*)}	132	418	260	200	240	150	418	
ACS580-01-363A-4	R9	200	363	345	200	293	160	498	361	300	302	250	542	
ACS580-01-430A-4	R9	250	430	400	200	363 ^{**)}	200	545	414	350	361	300	542	
ACS580-01-490A-4	R9	250	490	480	250	385	200	600	454	400	385	300	600	
ACS580-01-595A-4	R9e	315	595	590	315	505	250	858	575	422	505	335	858	
ACS580-01-670A-4	R9e	355	670	660	355	595	315	954	625	476	585	422	954	

Nominal ratings, ACS580-01

I_N	Rated current available continuously without overloadability at 40 °C.
P_N	Typical motor power in no-overload use.

Maximum output current

I_{max}	Maximum output current. Available for 2 seconds at start.
-----------	---

Light-overload use

I_{Ld}	Continuous current allowing 110% I_{Ld} for 1 minute every 10 minutes at 40 °C.
P_{Ld}	Typical motor power in light-duty use.

Heavy-duty use

I_{Hd}	Continuous current allowing 150% I_{Hd} for 1 minute every 10 minutes at 40 °C. *) Continuous current allowing 130% I_{Hd} for 1 minute every 10 minutes at 40 °C. **) Continuous current allowing 125% I_{Hd} for 1 minute every 10 minutes at 40 °C.
P_{Hd}	Typical motor power in heavy-duty use.

The ratings apply for the frames R1 to R9 up to +40 °C in enclosure class IP21.

For derating at higher altitudes, temperatures, switching frequencies or enclosure classes, see the HW manuals, document codes: 3AXD50000044794 and 3AXD50000015497.

Drive modules, ACS580-04 (3-phase supply voltage range 380-480 V)

Frame type	Frame size	3-phase, $U_N = 400$ V							3-phase, $U_N = 480$ V				
		Nominal ratings		Light-duty use		Heavy-duty use		Max. output current	Light-duty use		Heavy-duty use		Max. output current
		P_N (kW)	I_N (A)	I_{Ld} (A)	P_{Ld} (kW)	I_{Hd} (A)	P_{Hd} (kW)		I_{max} (A)	I_{Ld} (A)	P_{Ld} (hp)	I_{Hd} (A)	
ACS580-04-505A-4	R10	250	505	485	250	361	200	560	483	400	361	300	560
ACS580-04-585A-4	R10	315	585	575	315	429	250	730	573	450	414	350	730
ACS580-04-650A-4	R10	355	650	634	355	477	250	730	623	500	477	400	730
ACS580-04-725A-4	R11	400	725	715	400	566	315	1020	705	600	566	450	850
ACS580-04-820A-4	R11	450	820	810	450	625	355	1020	807	700	625	500	1020
ACS580-04-880A-4	R11	500	880	865	500	725 ^{*)}	400	1100	807	700	625	500	1020

Cabinet-built drives, ACS580-07 (3-phase supply voltage range 380-480 V)

Frame type	Frame size	3-phase, $U_N = 400$ V							3-phase, $U_N = 480$ V				
		Nominal ratings		Light-duty use		Heavy-duty use		Max. output current	Light-duty use		Heavy-duty use		Max. output current
		P_N (kW)	I_N (A)	I_{Ld} (A)	P_{Ld} (kW)	I_{Hd} (A)	P_{Hd} (kW)		I_{max} (A)	I_{Ld} (A)	P_{Ld} (hp)	I_{Hd} (A)	
ACS580-07-0062A-4	R4	30	62	58	30	45	22	81	52	40	40	30	72
ACS580-07-0073A-4	R4	37	73	68	37	61	30	110	65	50	52	40	79
ACS580-07-0089A-4	R4	45	89	83	45	72	37	130	77	60	65	50	117
ACS580-07-0106A-4	R5	55	106	100	55	87	45	157	96	75	77	60	148
ACS580-07-0145A-4	R6	75	145	138	75	105	55	178	124	100	96	75	178
ACS580-07-0169A-4	R7	90	169	161	90	145	75	247	156	125	124	100	247
ACS580-07-0206A-4	R7	110	206	196	110	169	90	287	180	150	156	125	287
ACS580-07-0246A-4	R8	132	246	234	132	206	110	350	240	200	180	150	350
ACS580-07-0293A-4	R8	160	293	278	160	246 ^{**))}	132	418	260	200	240	150	418
ACS580-07-0363A-4	R9	200	363	345	200	293	160	498	361	300	302	250	542
ACS580-07-0430A-4	R9	250	430	400	200	363 ^{***))}	200	617	414	350	361	300	542
ACS580-07-0505A-4	R10	250	505	485	250	361	200	560	483	400	361	300	560
ACS580-07-0585A-4	R10	315	585	575	315	429	250	730	573	450	414	350	730
ACS580-07-0650A-4	R10	355	650	634	355	477	250	730	623	500	477	400	730
ACS580-07-0725A-4	R11	400	725	715	400	566	315	1020	705	600	566	450	850
ACS580-07-0820A-4	R11	450	820	810	450	625	355	1020	807	700	625	500	1020
ACS580-07-0880A-4	R11	500	880	865	500	725 ^{*)}	400	1100	807	700	625	500	1020

Nominal ratings, ACS580-04 and ACS580-07

I_N	Rated current available continuously without overloadability at 40 °C.
P_N	Typical motor power in no-overload use.

Maximum output current

I_{max}	Maximum output current. Available for 2 seconds at start.
-----------	---

Light-overload use

I_{Ld}	Continuous current allowing 110% I_{Ld} for 1 minute every 10 minutes at 40 °C.
P_{Ld}	Typical motor power in light-duty use.

Heavy-duty use

I_{Hd}	Continuous current allowing 150% I_{Hd} for 1 minute every 10 minutes at 40 °C. *) Continuous current allowing 140% I_{Hd} for 1 minute every 10 minutes at 40 °C.)*) Continuous current allowing 130% I_{Hd} for 1 minute every 10 minutes at 40 °C.)*)*) Continuous current allowing 125% I_{Hd} for 1 minute every 10 minutes at 40 °C.
P_{Hd}	Typical motor power in heavy-duty use.

The ratings apply for the frames R6 to R9 up to +40 °C in enclosed IP class 21.

The ratings apply for the frames R10 to R11 up to +40 °C in enclosed IP00/IP20.

For derating at higher altitudes, temperatures or switching frequencies, see the HW manuals, document codes: 3AXD50000044794, 3AXD50000015497 and 3AXD50000045815.

DIMENSIONS

ACS580-01 IP66									
Frames	Height		Width		Depth		Weight		
	(mm)	(in)	(mm)	(in)	(mm)	(in)	(kg)	(lb)	
R1	522	20.6	208	8.2	249	9.8	11.8	26	
R2	606	23.9	208	8.2	260	10.2	14.5	32	
R3	647	25.5	277	10.9	260	10.2	26.4	58.2	



ACS580-01 IP21, standard										
Frames	Height 1		Height 2		Width		Depth		Weight	
	(mm)	(in)	(mm)	(in)	(mm)	(in)	(mm)	(in)	(kg)	(lb)
R1	373	14.7	-	-	125	4.9	223	8.8	4.6	10.1
R2	473	18.6	-	-	125	4.9	229	9	6.6	14.6
R3	490	19.3	-	-	203	8	229	9	11.8	26
R4	636	25	-	-	203	8	257	10.2	19	41.9
R5	732	28.8	596 *)	23.5	203	8	295	11.6	28.3	62.4
R6	727	28.6	548 *)	21.6	252	9.9	369	14.5	42.4	93.5
R7	880	34.6	600 *)	23.7	284	11.2	370	14.6	54	119.1
R8	965	38	680 *)	26.7	300	11.8	393	15.5	69	152.2
R9	955	37.6	680 *)	26.8	380	15	418	16.5	97	213.9
R9e	1130	44.5	-	-	416	16.4	520	20.5	185	407.9



Height 1: Total height of the drive with glandbox
 Height 2: Total height of the drive without glandbox
 *) Height with the option +P944

ACS580-01 IP55, +B056										
Frames	Height 1		Height 2		Width		Depth		Weight	
	(mm)	(in)	(mm)	(in)	(mm)	(in)	(mm)	(in)	(kg)	(lb)
R1	403	15.9	403	15.9	128	5	233	9.2	4.8/5.4	10.6/11.2
R2	503	19.8	503	19.8	128	5	239	9.4	6.8/7.4	15.0/16.3
R3	490	19.3	733	28.9	206	8.1	237	9.3	13/15	28.7/33.1
R4	636	23.6	879	34.6	203	8	265	10.2	20/23.3	44.1/51.4
R5	732	28.8	1023	40.3	203	8	320	12.6	29/33	64/72.8
R6	727	28.6	-	-	252	9.9	380	15	43	94.8
R7	880	34.6	-	-	284	11.2	381	15	56	123.5
R8	965	38	-	-	300	11.8	452	17.8	77	169.8
R9	955	37.6	-	-	380	15	477	18.78	103	227.1
R9e	1130	44.5	-	-	416	16.4	535	21.3	189	407.9



Height 1: Total height of the drive
 Height 2: Total height of the drive with options +F287, +F316, +E223
 Note: Options +F287, +F316, +E223 are available only for the IP55 frames R1-R5

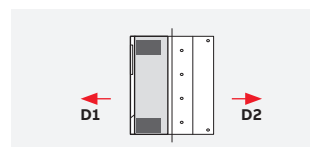

ACS580-01 flange mounting dimensions, with +C135 or a loose option kit for IP21										
Frames	Height		Width		D1		D2		Weight	
	(mm)	(in)	(mm)	(in)	(mm)	(in)	(mm)	(in)	(kg)	(lb)
R1	461	18.2	206	8.1	133	5.2	109	4.3	4.6	10.1
R2	551	21.7	206	8.1	130	5.1	114	4.5	6.5	14.6
R3	613	24.1	290	11.4	118	4.6	116	4.6	11.8	26
R4	776	30.6	290	11.4	120	4.7	137	5.4	19	41.9
R5	776	30.6	290	11.4	124	4.9	173	6.8	28.3	62.4
R6	672	26.5	374	14.7	193	7.6	167	6.6	42.4	93.5
R7	722	28.4	406	16	194	7.6	169	6.7	54	119.1
R8	814	32.1	433	17	202	8	184	7.2	69	152.2
R9	804	31.7	502	19.8	204	8	209	8.2	97	213.9
R9e	1237	48.7	555	21.9	340	13.4	176	6.9	185	407.9



ACS580-04 IP00, standard

Frames	Height		Width		Depth		Weight	
	(mm)	(in)	(mm)	(in)	(mm)	(in)	(kg)	(lb)
R10	1462	57.6	350	13.8	529	20.8	162	357.2
R11	1662	63.4	350	13.8	529	20.8	200	440.9

ACS580-04 IP20, +B051

Frames	Height		Width		Depth		Weight	
	(mm)	(in)	(mm)	(in)	(mm)	(in)	(kg)	(lb)
R10	1462	57.6	350	13.8	529	20.8	162	357.2
R11	1662	63.4	350	13.8	529	20.8	200	440.9



ACS580-07 IP21, standard

Frames	Height		Width		Depth		Weight	
	(mm)	(in)	(mm)	(in)	(mm)	(in)	(kg)	(lb)
R4	2145	84.4	430	16.9	673	26.5	200	463
R5	2145	84.4	430	16.9	673	26.5	210	463
R6	2145	84.4	430	16.9	673	26.5	210	463
R7	2145	84.4	430	16.9	673	26.5	220	485
R8	2145	84.4	530	20.9	673	26.5	255	562
R9	2145	84.4	530	20.9	673	26.5	275	606
R10	2145	84.4	830	32.7	698	27.5	410	904
R11	2145	84.4	830	32.7	698	27.5	440	970



ACS580-07 IP42, +B054

Frames	Height		Width		Depth		Weight	
	(mm)	(in)	(mm)	(in)	(mm)	(in)	(kg)	(lb)
R4	2145	84.4	430	16.9	673	26.5	200	463
R5	2145	84.4	430	16.9	673	26.5	210	463
R6	2145	84.4	430	16.9	673	26.5	210	463
R7	2145	84.4	430	16.9	673	26.5	220	485
R8	2145	84.4	530	20.9	673	26.5	255	562
R9	2145	84.4	530	20.9	673	26.5	275	606
R10	2145	84.4	830	32.7	698	27.5	410	904
R11	2145	84.4	830	32.7	698	27.5	440	970



ACS580-07 IP54, +B055

Frames	Height		Width		Depth		Weight	
	(mm)	(in)	(mm)	(in)	(mm)	(in)	(kg)	(lb)
R4	2145	84.4	430	16.9	673	26.5	200	463
R5	2145	84.4	430	16.9	673	26.5	210	463
R6	2145	84.4	430	16.9	673	26.5	210	463
R7	2145	84.4	430	16.9	673	26.5	220	485
R8	2145	84.4	530	20.9	673	26.5	255	562
R9	2145	84.4	530	20.9	673	26.5	275	606
R10	2315	91.14	830	32.7	698	27.5	410	904
R11	2315	91.14	830	32.7	698	27.5	440	970



COOLING AND FUSES

Wall-mounted drives, ACS580-01

Cooling air flow and recommended input protection fuses for 200 to 240 V units								
Type designation	Frame size	Cooling air flow 200 to 240 V units				Recommended input protection fuses for 200 to 240 V units		
		Typical heat dissipation *)	Air flow		Max. noise level **)	IEC fuses		
			(W)	(m ³ /h)		(ft ³ /min)	(A)	Fuse type
ACS580-01-04A7-2	R1	51	43	25	59	25	gG	
ACS580-01-06A7-2	R1	70	43	25	59	25	gG	
ACS580-01-07A6-2	R1	80	43	25	59	25	gG	
ACS580-01-012A-2	R1	142	43	25	59	25	gG	
ACS580-01-018A-2	R1	228	43	25	59	25	gG	
ACS580-01-025A-2	R2	253	101	59	64	40	gG	
ACS580-01-032A-2	R2	358	101	59	64	40	gG	
ACS580-01-047A-2	R3	527	179	105	76	63	gG	
ACS580-01-060A-2	R3	775	179	105	76	63	gG	
ACS580-01-076A-2	R4	811	159	94	70	100	gG	
ACS580-01-091A-2	R4	917	159	94	70	125	gG	
ACS580-01-115A-2	R5	1285	139	82	63	125	gG	
ACS580-01-144A-2	R6	1932	435	256	67	200	gG	
ACS580-01-171A-2	R7	2000	450	265	67	250	gG	
ACS580-01-213A-2	R7	2854	450	265	67	315	gG	
ACS580-01-276A-2	R8	3567	550	324	65	400	gG	

*) Heat dissipation value is a reference for cabinet thermal design. According to Ecodesign regulations.

**) The maximum noise level at full fan speed. When the drive is not operating at full load and at maximum ambient temperature the noise level is lower.

Cooling air flow and recommended input protection fuses for 380 to 480 V units										
Type designation	Frame size	Cooling air flow 380 to 480 V units				Recommended input protection fuses for 380 to 480 V units ***)				
		Typical heat dissipation *)	Air flow		Max. noise level **)	IEC fuses		UL fuses		
			(W)	(m ³ /h)		(ft ³ /min)	(dBA)	(A)	Fuse type	(A)
ACS580-01-02A7-4	R1	41	43	25	55	4	gG	15	UL Class T	
ACS580-01-03A4-4	R1	48	43	25	55	6	gG	15	UL Class T	
ACS580-01-04A1-4	R1	57	43	25	55	6	gG	15	UL Class T	
ACS580-01-05A7-4	R1	82	43	25	55	10	gG	15	UL Class T	
ACS580-01-07A3-4	R1	95	43	25	55	10	gG	15	UL Class T	
ACS580-01-09A5-4	R1	133	43	25	55	16	gG	15	UL Class T	
ACS580-01-12A7-4	R1	210	43	25	55	16	gG	15	UL Class T	
ACS580-01-018A-4	R2	237	101	59	66	25	gG	30	UL Class T	
ACS580-01-026A-4	R2	380	101	59	66	32	gG	30	UL Class T	
ACS580-01-033A-4	R3	495	179	105	76	40	gG	40	UL Class T	
ACS580-01-039A-4	R3	528	179	105	76	50	gG	60	UL Class T	
ACS580-01-046A-4	R3	680	179	105	76	63	gG	60	UL Class T	
ACS580-01-062A-4	R4	777	150	88	70	80	gG	80	UL Class T	
ACS580-01-073A-4	R4	858	150	88	70	100	gG	90	UL Class T	
ACS580-01-089A-4	R4	1028	159	94	70	100	gG	110	UL Class T	
ACS580-01-106A-4	R5	1287	139	82	63	125	gG	150	UL Class T	
ACS580-01-145A-4	R6	1956	435	256	67	160	gG	200	UL Class T	
ACS580-01-169A-4	R7	2017	450	265	67	250	gG	225	UL Class T	
ACS580-01-206A-4	R7	2781	450	265	67	315	gG	300	UL Class T	
ACS580-01-246A-4	R8	3130	550	324	65	355	gG	350	UL Class T	
ACS580-01-293A-4	R8	4067	550	324	65	425	gG	400	UL Class T	
ACS580-01-363A-4	R9	4835	1150	677	68	500	gG	500	UL Class T	
ACS580-01-430A-4	R9	6068	1150	677	68	630	gG	600	UL Class T	
ACS580-01-490A-4	R9	5831	1150	677	68	630	gG	600	UL Class T	
ACS580-01-595A-4	R9e	6559	1207	710	75	1600	uR	800	UL Class T	
ACS580-01-670A-4	R9e	6801	1207	710	75	1600	uR	800	UL Class T	

*) Heat dissipation value is a reference for cabinet thermal design. According to Ecodesign regulations.

**) The maximum noise level at full fan speed. When the drive is not operating at full load and at maximum ambient temperature the noise level is lower.

***) For detailed fuse sizes and types, please see the ACS580 HW manuals, document codes: 3AXD50000044794 and 3AXD50000015497.

Note: For flange mounting, please refer to the ACS580 HW manuals, document codes: 3AXD50000044794 and 3AXD50000015497.

Cooling

ACS580 drives are fitted with variable-speed cooling air fans. The cooling air must be free from corrosive materials and not exceed the maximum ambient temperature of 40 °C for frames R1 to R9 (50 °C with derating). The speed-controlled fans cool the drive only when needed, which reduces overall noise level and energy consumption.

Fuse connections

Standard fuses can be used with ABB general purpose drives. For input fuses, see the tables on pages 30-31.

Drive modules, ACS580-04

Cooling air flow and recommended input protection fuses for 380 to 480 V units										
Type designation	Frame size	Cooling air flow 380 to 480 V units, IP21 and IP42 (UL Type 1)					Recommended input protection fuses for 380 to 480 V units ^{***)}			
		Typical heat dissipation ^{*)}	Air flow		Max. noise level ^{**)}	IEC fuses		UL fuses		
			(W)	(m ³ /h)		(ft ³ /min)	(dBA)	(A)	Fuse type	(A)
ACS580-04-505A-4	R10	6454	1200	707	72	***)	***)	***)	***)	***)
ACS580-04-585A-4	R10	6828	1200	707	72	***)	***)	***)	***)	***)
ACS580-04-650A-4	R10	8036	1200	707	72	***)	***)	***)	***)	***)
ACS580-04-725A-4	R11	8095	1200	707	72	***)	***)	***)	***)	***)
ACS580-04-820A-4	R11	9641	1200	707	72	***)	***)	***)	***)	***)
ACS580-04-880A-4	R11	10874	1420	848	72	***)	***)	***)	***)	***)

^{*)} Heat dissipation value is a reference for cabinet thermal design. According to Ecodesign regulations.

^{**)} The maximum noise level at full fan speed. When the drive is not operating at full load and at maximum ambient temperature the noise level is lower.

^{***)} For detailed fuse sizes and types, please see the ACS580 HW manuals, document codes: 3AXD50000044794 and 3AXD50000015497.

Cabinet-built drives, ACS580-07

Cooling air flow and recommended input protection fuses for 380 to 480 V units										
Type designation	Frame size	Cooling air flow 380 to 480 V units					Recommended input protection fuses for 380 to 480 V units ^{***)}			
		Typical heat dissipation ^{*)}	Air flow		Max. noise level ^{**)}	IEC fuses		UL fuses		
			(W)	(m ³ /h)		(ft ³ /min)	(dBA)	(A)	Fuse type	(A)
ACS580-07-0062A-4	R4	803	400	235	70	100	170M3812D	80	DFJ-80	
ACS580-07-0073A-4	R4	882	400	235	70	125	170M3813D	100	DFJ-100	
ACS580-07-0089A-4	R4	1059	409	241	63	160	170M3814D	100	DFJ-100	
ACS580-07-0106A-4	R5	1290	389	229	63	200	170M3815D	150	DFJ-150	
ACS580-07-0145A-4	R6	2487	685	403	67	250	170M3816D	250	DFJ-250	
ACS580-07-0169A-4	R7	2497	700	412	67	250	170M3816D	300	DFJ-300	
ACS580-07-0206A-4	R7	3314	700	412	67	315	170M3817D	300	DFJ-300	
ACS580-07-0246A-4	R8	3806	800	471	65	400	170M5408	400	170M5408	
ACS580-07-0293A-4	R8	4942	800	471	65	500	170M5410	500	170M5410	
ACS580-07-0363A-4	R9	5868	1400	824	68	630	170M6410	630	170M6410	
ACS580-07-0430A-4	R9	7600	1400	824	68	700	170M6411	700	170M6411	
ACS580-07-0505A-4	R10	8353	1900	1118	72	800	170M6412	***)	***)	
ACS580-07-0585A-4	R10	9471	1900	1118	72	900	170M6413	***)	***)	
ACS580-07-0650A-4	R10	11200	1900	1118	72	1000	170M6414	***)	***)	
ACS580-07-0725A-4	R11	11386	2400	1413	72	1250	170M6416	***)	***)	
ACS580-07-0820A-4	R11	13725	2400	1413	72	1250	170M6416	***)	***)	
ACS580-07-0880A-4	R11	15300	2620	1542	72	1400	170M6417	***)	***)	

^{*)} Heat dissipation value is a reference for cabinet thermal design. According to Ecodesign regulations.

^{**)} The maximum noise level at full fan speed. When the drive is not operating at full load and at maximum ambient temperature the noise level is lower.

^{***)} For detailed fuse sizes and types, please see the ACS580 HW manuals, document codes:

3AXD50000044794, 3AXD50000015497 and 3AXD50000045815.

CIRCUIT BREAKERS

Circuit breakers are automatically-operated electrical switches for protecting electrical circuits from excess currents causing damage. The circuit breakers listed below are tested and approved for use with the ABB drives. Other circuit breakers can also be used with the drives if they provide the same electrical characteristics.

ACS580-01							
Type designation ACS580-01-	Frame size	Aux. Contr. Volt.:	Miniature circuit breaker	T_{max} moulded case circuit breaker	Switch-disconnector		Main contactor (≤ 40 °C)
					Main Switch	Main Switch UL	
			ABB type	ABB type	ABB type	ABB type	ABB type
3-phase, $U_N = 400$ or 480 V (380...415 V, 440...480 V)							
02A7-4	R1	230/115	S 303P-B/C/Z 10	-	OT16F3	OT16F3	AF09-30-22-13
03A4-4	R1	230/115	S 303P-B/C/Z 10	-	OT16F3	OT16F3	AF09-30-22-13
04A1-4	R1	230/115	S 303P-B/C/Z 10	-	OT16F3	OT16F3	AF09-30-22-13
05A7-4	R1	230/115	S 303P-B/C/Z 10	-	OT16F3	OT16F3	AF09-30-22-13
07A3-4	R1	230/115	S 303P-B/C/Z 10	-	OT16F3	OT16F3	AF09-30-22-13
09A5-4	R1	230/115	S 303P-B/C/Z 10	-	OT16F3	OT16F3	AF09-30-22-13
12A7-4	R1	230/115	S 303P-B/C/Z 16	-	OT16F3	OT16F3	AF09-30-22-13
018A-4	R2	230/115	S 303P-B/C/Z 20	-	OT25F3	OT25F3	AF09-30-22-13
026A-4	R2	230/115	S 303P-B/C/Z 25	-	OT25F3	OT25F3	AF12-30-22-13
033A-4	R3	230/115	S 303P-B/C/Z 32	-	OT63F3	OT63F3	AF26-30-22-13
039A-4	R3	230/115	S 303P-B/C/Z 40	-	OT63F3	OT63F3	AF52-30-22-13
046A-4	R3	230/115	S 303P-B/C/Z 50	-	OT63F3	OT63F3	AF52-30-22-13
062A-4	R4	230/115	S 803S-B/C 80	-	OT100F	OT100F	AF52-30-22-13
073A-4	R4	230/115	S 803 S-B/C 75	1SDA067918R1 Prospective SC current 65kA	OT100F	OT100F	AF52-30-22-13
089A-4	R4	230/115	S 803S-B/C 100	1SDA067918R1 Prospective SC current 65kA	OT160EV	OT200U	AF65-30-22-13
106A-4	R5	230/115	S 803S-B/C 125	1SDA068555R1 Prospective SC current 65kA	OT160EV	OT200U	AF146-30-22-13
145A-4	R6	230/115	XT4 L 250 Ekip LS/I $I_n = 250$ 3p F F	1SDA068555R1 Prospective SC current 65kA	OT160EV	OT200U	AF146-30-22-13
169A-4	R7	230/115	XT4 L 250 Ekip LS/I $I_n = 250$ 3p F F	1SDA068555R1 Prospective SC current 65kA	OT250E	OT400U	AF146-30-22-13
206A-4	R7	230/115	T4 L 320 PR221DS-LS/I $I_n = 320$ 3p F F	1SDA054141R1 Prospective SC current 65kA	OT250E	OT400U	AF146-30-22-13
246A-4	R8	230/115	T5 L 400 PR221DS-LS/I $I_n = 400$ 3p F F	1SDA054365R1 Prospective SC current 65kA	OT400E	OT400U	AF265-30-22-13
293A-4	R8	230/115	T5 L 630 PR221DS-LS/I $I_n = 630$ 3p F F	1SDA054420R1 Prospective SC current 65kA	OT400E	OT400U	AF265-30-22-13
363A-4	R9	230/115	T5 L 630 PR221DS-LS/I $I_n = 630$ 3p F F	1SDA054420R1 Prospective SC current 65kA	OT630E	OT600U	AF400-30-22-70
430A-4	R9	230/115	T5 L 630 PR221DS-LS/I $I_n = 630$ 3p F F	1SDA054420R1 Prospective SC current 65kA	OT630E	OT600U	AF400-30-22-70
490A-4	R9	230/115	T5 L 630 PR221DS-LS/I $I_n = 630$ 3p F F	1SDA054420R1 Prospective SC current 65kA	OT630E	OT600U	AF400-30-22-70
595A-4	R9e	230/115	-	-	-	-	-
670A-4	R9e	230/115	-	-	-	-	-

ACS580-04							
Type designation ACS580-04-	Frame size	Aux. Contr. Volt.:	Miniature circuit breaker	T_{max} moulded case circuit breaker	Switch-disconnector		Main contactor (≤ 40 °C)
					Main Switch	Main Switch UL	
			ABB type	ABB type	ABB type	ABB type	ABB type
$U_N = 380...480$ V (380, 400, 415 V)							
505A-4	R10	230/115	-	1SDA054412R1 (T5H 630 PR221DS-LS/I $I_n = 630$ 3p F F)	OT630E	OT600U	-
585A-4	R10	230/115	-	1SDA069428R1 (T6V 800 PR221DS-LS/I $I_n = 800$ 3p F F)	OT630E	OT600U	-
650A-4	R10	230/115	-	1SDA069428R1 (T6V 800 PR221DS-LS/I $I_n = 800$ 3p F F)	OT800E	OT800U	-
725A-4	R11	230/115	-	1SDA062770R1 (T7H 1000 PR231/P LS/I $I_n = 1000$ A 3p F F)	OT800E	OT800U	-
820A-4	R11	230/115	-	1SDA062770R1 (T7H 1000 PR231/P LS/I $I_n = 1000$ A 3p F F)	OT1000E	OT1200U	-
880A-4	R11	230/115	-	1SDA062770R1 (T7H 1000 PR231/P LS/I $I_n = 1000$ A 3p F F)	OT1000E	OT1200U	-

SINE FILTERS

Sine filters are low-pass filters that suppress the high frequency components of the drive output.

A sine filter consists of single- or three-phase reactors and delta- or star-connected capacitors. The sine filter provides true sinusoidal voltage waveform at the drive output by suppressing the high frequency voltage components of the drive output. Suppression of the high frequency voltage components is needed when extra-long motor cables are used, there is a step-up transformer between the drive and a motor, or when a drive is installed with an old direct-on-line motor.

ACS580-01, sine filters			
Type designation	Type code Sine filter IP00	Type code Housing case IP21 *)	$I_{cont. max}$ (A)
3-phase, $U_N = 380...480$ V. The power ratings are valid at nominal voltage 400 V (0.75 to 250 kW).			
ACS580-01-02A7-4	B84143V0004R229	B84143Q0002R229	2.3
ACS580-01-03A4-4	B84143V0004R229	B84143Q0002R229	3.1
ACS580-01-04A1-4	B84143V0004R229	B84143Q0002R229	3.8
ACS580-01-05A7-4	B84143V0006R229	B84143Q0002R229	5.3
ACS580-01-07A3-4	B84143V0011R229	B84143Q0004R229	6.9
ACS580-01-09A5-4	B84143V0011R229	B84143Q0004R229	9.2
ACS580-01-12A7-4	B84143V0016R229	B84143Q0006R229	12.1
ACS580-01-018A-4	B84143V0016R229	B84143Q0006R229	16
ACS580-01-026A-4	B84143V0025R229	B84143Q0008R229	24
ACS580-01-033A-4	B84143V0033R229	B84143Q0008R229	31
ACS580-01-039A-4	B84143V0050R229	B84143Q0010R229	37
ACS580-01-046A-4	B84143V0050R229	B84143Q0010R229	43
ACS580-01-062A-4	B84143V0066R229	B84143Q0010R229	58
ACS580-01-073A-4	B84143V0075R229	B84143Q0010R229	64
ACS580-01-089A-4	B84143V0095R229	B84143Q0012R229	77
ACS580-01-106A-4	B84143V0095R229	B84143Q0012R229	91
ACS580-01-145A-4	B84143V0162S229	B84143Q0014R229	126
ACS580-01-169A-4	B84143V0162S229	B84143Q0014R229	153
ACS580-01-206A-4	B84143V0230S229	B84143Q0016R229	187
ACS580-01-246A-4	B84143V0230S229	B84143Q0016R229	209
ACS580-01-293A-4	B84143V0390S229	B84143Q0018R229	249
ACS580-01-363A-4	B84143V0390S229	B84143Q0018R229	297
ACS580-01-430A-4	B84143V0390S229	B84143Q0018R229	352
ACS580-01-490A-4	NSIN0900-6		
ACS580-01-595A-4	NSIN0900-6		
ACS580-01-670A-4	NSIN0900-6		

*) If a sinus filter IP21 is needed please order both type codes for Housing case IP21 and Sine filter IP00.

Example: if a IP21 sine filter is needed for an ACS580-01-02A7-4 it is necessary to order both B84143V0004R229 and B84143Q0002R229.

External du/dt filter for ACS580-01

ACS580 220 to 240 V	du/dt filter type												
	Unprotected (IP00)					Protected to IP22			Protected to IP54				
	NOCH0016-60	NOCH0030-60	FOCH0320-50	FOCH0610-70	FOCH0875-70	NOCH0016-62	NOCH0030-62	NOCH0070-62	NOCH0120-62	NOCH0016-65	NOCH0030-65	NOCH0120-65	BOCH-0880A-7
ACS580-01-04A7-2	•					•				•			
ACS580-01-06A7-2	•					•				•			
ACS580-01-07A6-2	•					•				•			
ACS580-01-012A-2	•					•				•			
ACS580-01-018A-2	•					•				•			
ACS580-01-025A-2		•					•				•		
ACS580-01-032A-2		•					•				•		
ACS580-01-047A-2			•					•				•	
ACS580-01-060A-2			•					•				•	
ACS580-01-089A-2			•					•				•	
ACS580-01-115A-2				•					•				•
ACS580-01-144A-2					•								
ACS580-01-144A-2+B056					•								
ACS580-01-171A-2					•								
ACS580-01-171A-2+B056					•								
ACS580-01-213A-2					•								
ACS580-01-213A-2+B056					•								
ACS580-01-276A-2					•								
ACS580-01-276A-2+B056					•								

External du/dt filters for ACS580-07

ACS580 400 V	du/dt filter type		
	Protected to IP54		
	BOCH-0880A-7	COF-01	COF-02
ACS580-07-0145A-4		•	
ACS580-07-0169A-4		•	
ACS580-07-0206A-4		•	
ACS580-07-0246A-4			•
ACS580-07-0293A-4			•
ACS580-07-0363A-4			•
ACS580-07-0430A-4			•
ACS580-07-0505A-4	•		
ACS580-07-0585A-4	•		
ACS580-07-0650A-4	•		
ACS580-07-0725A-4	•		
ACS580-07-0820A-4	•		
ACS580-07-0880A-4	•		

Dimensions and weights of the du/dt filters

du/dt filter	Height	Width	Depth	Weight
*) 3 filters included, dimensions apply to one filter.				
	(mm)	(mm)	(mm)	(kg)
NOCH0016-60	195	140	115	2.4
NOCH0016-62/65	323	199	154	6
NOCH0030-60	215	165	130	4.7
NOCH0030-62/65	348	249	172	9
NOCH0070-60	261	180	150	9.5
NOCH0070-62/65	433	279	202	15.5
NOCH0120-60*)	200	154	106	7
NOCH0120-62/65	765	308	256	45
FOCH0260-70	382	340	254	47
FOCH0320-50	662	319	293	65
FOCH0610-70	662	319	293	65
FOCH0875-70	662	319	293	65
BOCH-0880A-7	400	248	456	18
COF-01	570	296	360	23
COF-02	570	360	301	23

EMC – ELECTROMAGNETIC COMPATIBILITY

What is EMC?

EMC stands for electromagnetic compatibility. It is the ability of electrical/electronic equipment to operate without problems in an electromagnetic environment.

Likewise, the equipment must not disturb or interfere with any other product or system in its locality. This is a legal requirement for all equipment taken into service within the European Economic Area (EEA).

Installation environments

A power drive system (PDS) can be connected to either industrial or public power distribution networks. The environment class depends on the way the PDS is connected to power supply.

The **1st environment** includes domestic premises. It also includes establishments directly connected without an intermediate transformer to a low voltage power supply network that supplies buildings used for domestic purposes.

The **2nd environment** includes all establishments directly connected to public low voltage power supply networks.

EMC solutions

To fulfill the EMC requirements, the drives are equipped with standard or optional RFI filtering for HF disturbances.

- Using ferrite rings in power connection points
- Using an AC or DC choke (while they are meant to protect against harmonics, they reduce HF disturbances as well)
- Using an LCL filter in the case of regenerative drives
- Using a du/dt filter

Immunity and emission compatibility

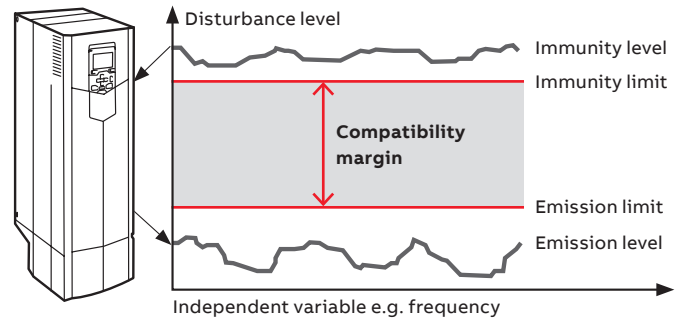

Installation environments

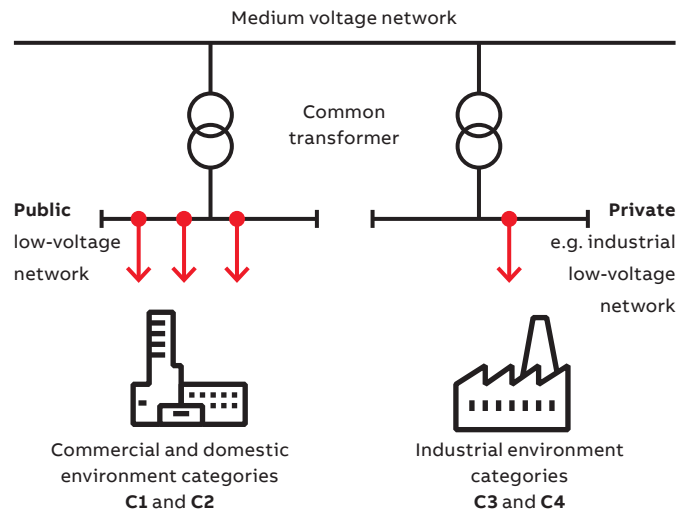

THE PRODUCT STANDARD EN 61800-3 DIVIDES PDS INTO FOUR CATEGORIES ACCORDING TO THE INTENDED USE

C1 – 1st environment

- Household appliances
- Usually plug connectible to any wall outlet
- Anyone can connect these to the network
- Examples: washing machines, TV sets, computers, microwave ovens, etc.

C2 – 1st environment

- Fixed household and public appliances
- Need to be installed or operated by a professional
- Examples: elevators, rooftop fans, residential booster pumps, gates and barriers, supermarket freezers, etc.

C3 – 2nd environment

- Professional equipment
- Needs to be installed or operated by a professional
- In some rare cases, may also be pluggable
- Examples: any equipment for industrial usage only, such as conveyors, mixers, etc.

C4 – 2nd environment

- Professional equipment
- Needs to be fixed installation and operated by a professional
- Examples: paper machines, rolling mills, etc.

Every ACS580 drive is equipped with a built-in filter to reduce high-frequency emissions.

ACS580-01 wall-mounted drives fulfill the EMC requirements of Category C2 of product standard EN 61800-3.

The ACS580-07 cabinet-built drives and ACS580-04 drive modules fulfill the EMC requirements of Category C2 of product standard EN 61800-3. These EMC requirements are fulfilled without any external filters.

Optional EMC filters are available for the drives for even better EMC performance.

Comparison of EMC standards				
EN 61800-3, product standard	EN 61800-3, product standard	EN 55011, product family standard for industrial, scientific and medical (ISM) equipment	EN 61000-6-4, generic emission standard for industrial environments	EN 61000-6-3, generic emission standard for residential, commercial and light-industrial environments
Category C1	1 st environment, unrestricted distribution	Group 1. Class B	Not applicable	Applicable
Category C2	1 st environment, restricted distribution	Group 1. Class A	Applicable	Not applicable
Category C3	2 nd environment, unrestricted distribution	Group 2. Class A	Not applicable	Not applicable
Category C4	2 nd environment, restricted distribution	Not applicable	Not applicable	Not applicable

EMC compliance and maximum cable length of ACS580-01/07 units *)						
Type	Voltage	Frame sizes	1 st environment, restricted distribution, C1, grounded network (TN)	1 st environment, restricted distribution, C2, grounded network (TN)	2 nd environment, unrestricted distribution, C3, grounded network (TN)	2 nd environment, unrestricted distribution, C3, ungrounded network (IT)
ACS580-01	380-480 V	R1-R5	With the plus codes: +F316, +E223, cable length 10 m	Standard device, cable length 100 m	Standard device, cable length 150 m	–
ACS580-01	380-480 V	R6-R9e **)	–	Standard device, cable length 150 m	Standard device, cable length 150 m	–
ACS580-04	380-480 V	R10-R11	–	With EMC filter option +E202, cable length 100 m	Standard device, cable length 100 m	–
ACS580-07	380-480 V	R4-R11	–	With EMC filter option +E202, cable length 100 m	Standard device, cable length 100 m	–

*) Motor cable operational functionality up to 300 m. See ACS580 hardware manuals [3AXD50000044794](#), [3AXD50000015497](#) and [3AXD50000045815](#) for frame specific information.

**) For R9e EMC C2 filter as option +E202

HARMONIC MITIGATION

What are harmonics?

Harmonic currents are created by non-linear loads connected to the power distribution system. Harmonic distortion is a form of pollution in the electric plant that can cause problems if the voltage distribution caused by harmonic currents increases above certain limits.

All power electronic converters used in different types of electronic systems can increase harmonic disturbances by injecting harmonic currents directly into the grid.

Electricity supply is hardly ever a pure sine wave voltage, and current that deviates from the sine form contains harmonics. The distortion is caused by non-linear loads connected to the electrical supply. Harmonics cause disturbances and equipment failures.

THE TOTAL CURRENT AS THE SUM OF THE FUNDAMENTAL AND 5TH HARMONICS

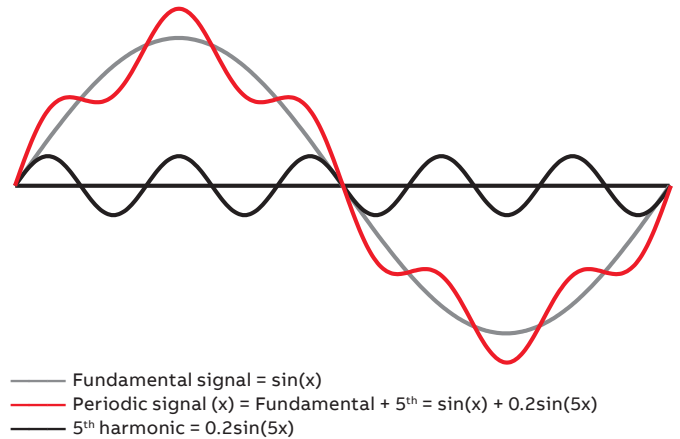

WHERE DO THE HARMONICS COME FROM?

Non-linear loads such as:

- Variable speed drives
- Uninterrupted power supplies (UPS)
- Industrial rectifiers
- Welding machines
- Fluorescent lighting systems (electronic ballast)
- Computers
- Printers
- Servers
- Electronic appliances

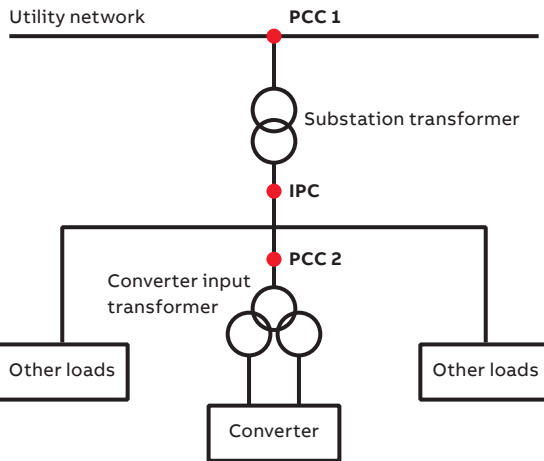

- Point of common coupling (**PCC**) is the point where the harmonic distortion is specified, e.g.
 - between the plant and the utility network (**PCC1**)
 - between the non-linear load and other loads within an industrial plant (**PCC 2**)

- In-plant point of coupling (**IPC**) is the point inside the customer system or installation to be studied

THE EFFECTS OF HARMONIC DISTORTIONS

Harmonic currents

- Mainly affect the power distribution system up to the rectifier:
- Additional losses in wires and cables
 - Extra heating of transformers
 - Circuit breaker malfunctioning

Harmonic voltage

- Can affect other equipment connected to the electrical system:
- Erratic operation of telecommunication systems, computers, video monitors, electronic test equipment, etc.
 - Resonance with power factor correction capacitors

ACS580 drives are compliant with EN 61000-3-12 harmonic limits. They are equipped with optimized:

- DC choke (R1-R9)
- AC choke (R9-R11)

By choosing the ACS580, you can automatically make your plant more reliable. Built-in chokes mitigate harmonics reducing disturbances and equipment failures. Smaller harmonic content also saves money and makes the installation easier because it allows smaller fuses and longer motor cables to be used. Less harmonics also means longer lifetime for the components and thus less maintenance needs and downtime.



Reliable operation



Reduced cost



Longer lifetime

DRIVE SYSTEM FEATURES AFFECTING HARMONICS

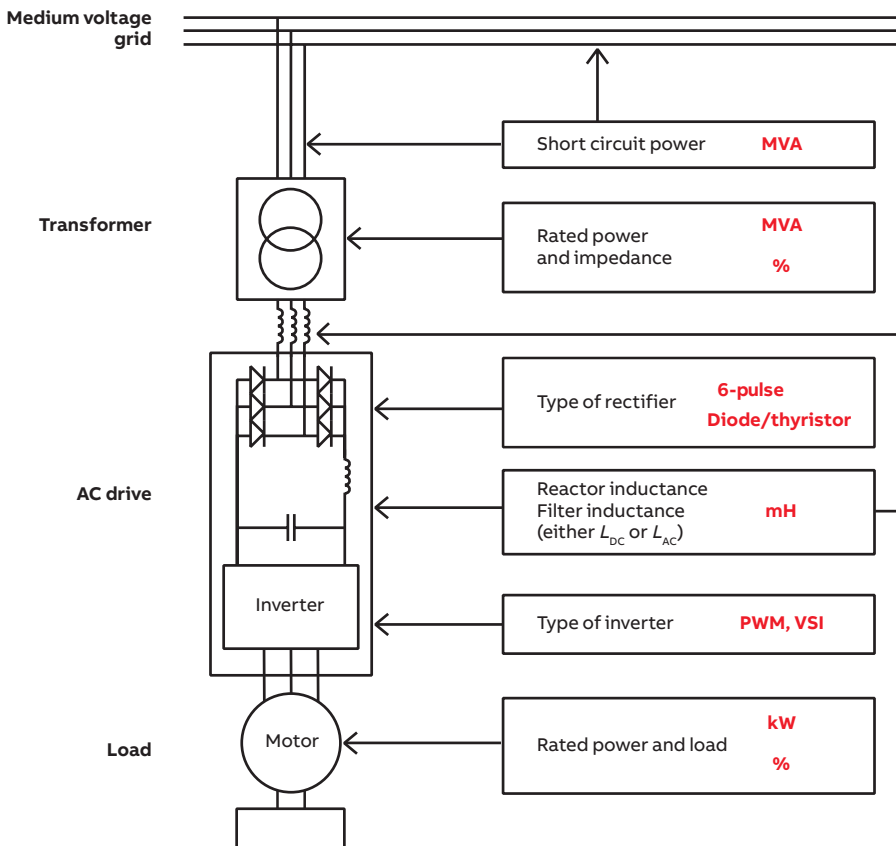

Harmonics reduction can be achieved either by structural modifications in the drive system or by using external filtering. The structural modifications may be to strengthen the supply, or to use 12 or more pulse drives, to use a controlled rectifier, or to improve the internal filtering in the drive.

The image to the left shows the factors in the AC drive system that have some influence on harmonics. The current harmonics depend on the drive construction, and the voltage harmonics are the current harmonics multiplied by the supply impedances.

EASINESS ON A WHOLE NEW LEVEL



The assistant control panel's intuitive user interface, assistants and ready-made macros offer simplicity for everyday life. The panel guides you through commissioning without a need to know any drive parameters and helps in unclear situations.

Assistant control panel, ACS-AP-S

Set up the drive, fine-tune motor control and monitor values that matter using the assistant control panel, delivered as standard with all ACS580 drives. The assistant control panel can also be used with the ACS480 and the ACS380.

Secure your back-ups

Assistant control panel automatically store your back-ups, which are easy to copy-paste to other drives by attaching the panel to another drive and restore the configuration.

Commission without a hassle

Select language, set time and date, name the drive, enter motor values, test rotating the motor.

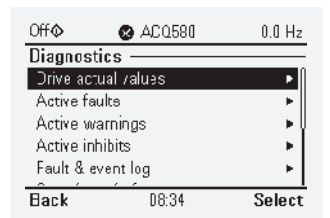
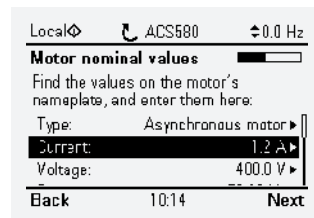
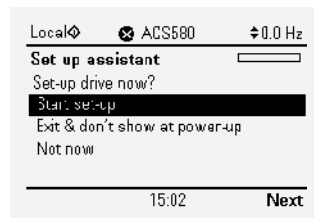

Primary settings

Primary settings and ready-made macros for a fast and easy way to set typical parameters.

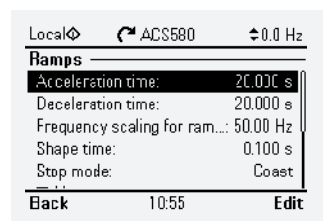
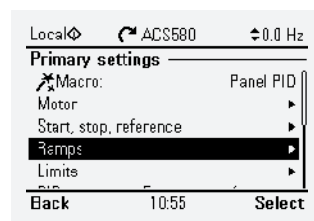
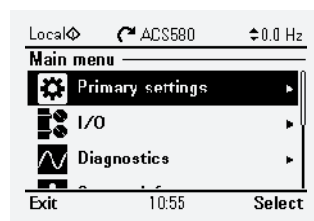

Input/output menu

Set and monitor your input/output (I/O) connections for real-time diagnostics.

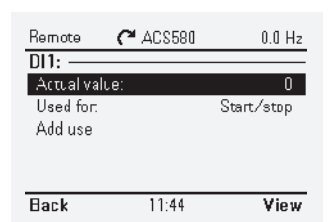
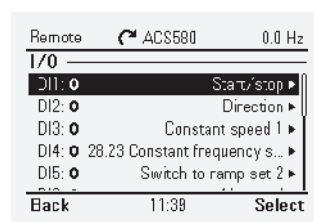
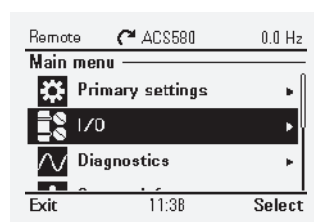

Home view displays

Monitor the values that are the most important to you. You can select values for monitoring from a ready-made list or choose user-defined parameters.

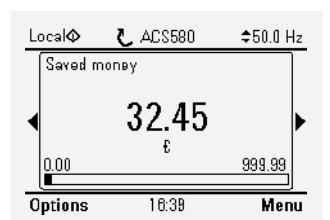
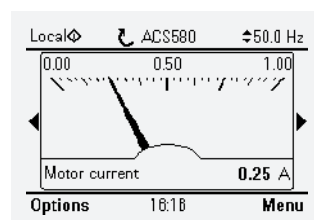
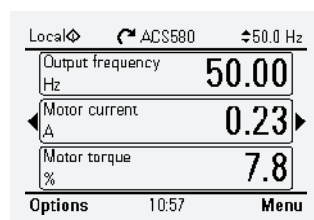

Help button

The help button provides more information about your selection and it can be pressed in any view.

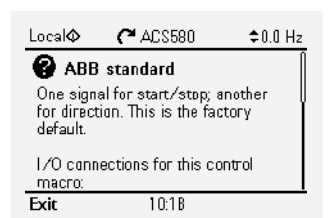
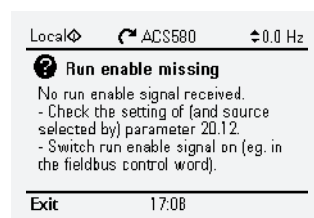
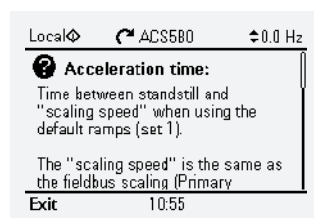



CONTROL PANEL OPTIONS AND MOUNTING KITS

The standard delivery of the ACS580 includes the assistant control panel (requires the +J400 code), but it can be also replaced by other control panels.



Bluetooth control panel, ACS-AP-W

The optional Bluetooth panel enables connection with the Drivetune mobile app. The app is available for free from Google Play and the Apple App store. Together with the Drivetune app and the Bluetooth panel, users can, for example, commission and monitor the drive remotely.



Control panel mounting platform, DPMP-01

This mounting platform is for surface mountings. This also requires CDUM-01 (blank control panel with the RJ-45 connector) and your control panel (assistant, basic, Bluetooth or industrial).



Industrial control panel, ACS-AP-I

The industrial control panel is compatible with all ABB drives, making it simple to use a single panel with different products.



Control panel mounting platform, DPMP-02

This mounting platform is for flush mountings. This also requires CDUM-01 (blank control panel with the RJ-45 connector) and your control panel (assistant, basic, Bluetooth or industrial).



Basic control panel, ACS-BP-S

The icon-based control panel supports users with parameter backup, settings and fault tracking in basic operation.



Door mounting kit, DPMP-EXT

The door mounting kit is ideal for cabinet installations. A kit for one drive includes one DPMP-02 and one CDPI-01 (blank control panel cover with RJ-45 connector). If a different control panel than the assistant panel is desired for cabinet door installation, it must be ordered separately.



Panel bus adapter, CDPI-01

The panel bus adapter is an ideal choice if there is a need to control multiple drives with a single control panel. The panel bus adapter offers also simplicity for cabinet installations as by using it the control panel can be installed on the cabinet door and the drive can be operated easily and safely.



Control panel mounting kit for outdoor installation DPMP-04/05

Enables control panel outdoor mounting thanks to IP66 protection class, UV resistance and IK07 impact protection rating.



Blank control panel, CDUM-01

The blank control panel can be used for covering the control panel slot if no control panel or panel bus adapter is needed.

DOOR MOUNTING AND DAISY CHAINING

Improve safety and leverage the full potential of the ACS580 control panel options with a door mounting kit and panel bus adapter.



Door mounting fosters easy operation and safety. It enables you to operate the drive without opening the cabinet door, saving time and keeping all the electronics behind the closed door. Up to 32 drives can be connected to one

control panel for even easier and quicker operation. When daisy chaining the drives, you need only one assistant control panel. The rest of the drives can be equipped with panel bus adapters.

Cabinet door

Door mounting kit, DPMP-EXT

The kit includes a surface mounting platform for the drive's control panel, panel bus adapter (CDPI-01) and an RJ-45 cable for connecting the control panel and the panel bus adapter.

Assistant control panel

The assistant control panel is delivered as standard with the ACS580 drives. Also a Bluetooth or industrial control panel can be used.

RJ-45 cable for daisy chaining drives

Panel bus adapter, CDPI-01

The panel bus adapter can be ordered with a plus code +J424 or with an MRP code 3AXD50000009843 as a loose option.



Cabinet, outside

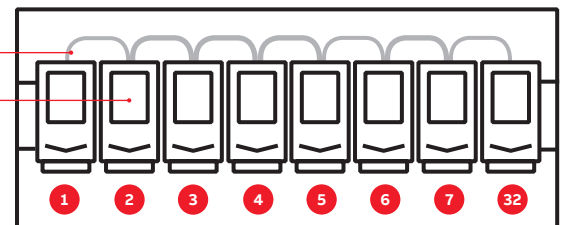

Cabinet, inside

CONTROL PANEL OPTIONS

The ACS-AP-S assistant control panel (plus code +J400) is included as standard in the delivery. If no code is mentioned in the ACS580 order, the assistant control panel is automatically added to the delivery. It can be replaced by one of the other +Jxxx options listed below.

MRP code	Plus code	Description	Type designation
3AUA0000064884	+J400	Assistant control panel	ACS-AP-S
3AXD5000025965	+J429	Control panel with Bluetooth interface *)	ACS-AP-W
3AUA0000088311	+J425	Industrial assistant control panel *)	ACS-AP-I
3AXD5000028828	+J404	Basic control panel	ACS-BP-S
3AXD5000009843	+J424	Blank control panel cover (no control panel delivered)	CDUM-01
3AXD5000004419	-	Panel bus adapter	CDPI-01
3AUA0000108878	-	Control panel mounting platform (flush mounted, requires also panel bus adapter on the drive)	DPMP-01
3AXD5000009374	-	Control panel mounting platform (surface mounted, requires also panel bus adapter on the drive)	DPMP-02
3AXD50000016230	-	Control panel mounting platform option, only for ACS580-04 modules	DPMP-03
3AXD50000217717	-	Control panel mounting kit for outdoor installation	DPMP-04
3AXD50000240319	-	Control panel mounting kit for outdoor installation, only for ACS580-04/34	DPMP-05
3AXD50000010763	-	Door mounting kit for the panel (for one drive, contains both DPMP-02 and CDPI-01)	DPMP-EXT

*) Compatible with ACS880 drives

DIGITAL CONNECTIVITY FOR DRIVES AND MOTORS

+ ABB Ability™ Mobile Connect for drives

Easy access to remote support

ABB Ability™ Mobile Connect for drives is a platform for remote drive support consisting of the Mobile Connect web portal and the Drivetune mobile app.

The platform allows ABB service partners to provide remote commissioning and troubleshooting support for personnel on-site without any complex connectivity infrastructure. Chats, sharing images and backups, viewing parameters online and sending support packages are all possible,

making your technical support process quick and efficient.

All that is needed is the Bluetooth control panel and a mobile device.

The platform is available for ABB partners and OEMs under a renewable subscription-based agreement.

[ABB Ability™ Mobile Connect for drives support portal](#)

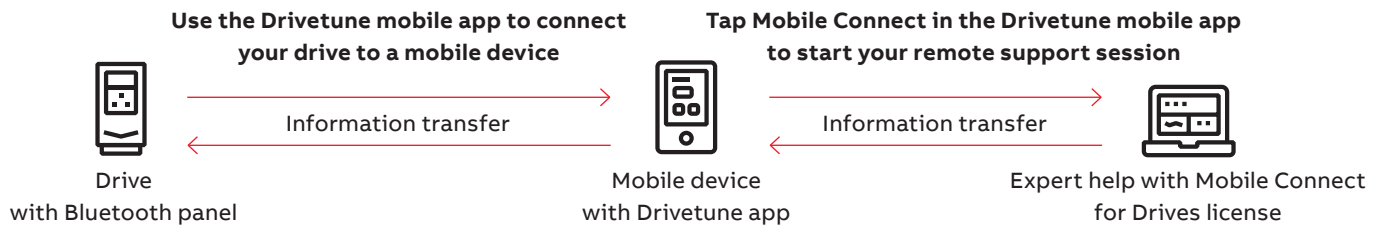

+ Drivetune mobile app for managing drives via an intuitive interface

Drivetune mobile app is a powerful tool for performing basic drive startup and troubleshooting tasks. It is possible to connect with drives and access data available in the Internet at the same time. The wireless Bluetooth

connectivity means that users won't need to enter hazardous or difficult-to-reach work areas to access information necessary to help them commission and tune the drive.



- **Startup, commission and tune your drive and application with full parameter access**
- **Optimize performance via drive troubleshooting features**
- **Create and share backups and support packages**
- **Keep track of drives installed base**

Download Drivetune mobile app



+ Drivetune mobile app

Motor QR code reader for quick and reliable motor parameter setting with ABB Drive-Motor package

Drivetune mobile app with motor QR code reader quickly and easily transfers ABB motor* data to drive parameters.



Faster and easier commissioning

- Quick and reliable motor parameter setup
- Scan the QR code or enter the motor serial number to get the data for parameters
- Less manual work and reduced risk of error when commissioning motors
- Drivetune helps to filter motor configurations



Easy to use

- Same motor QR code for ABB Access and Drivetune
- Share motor nameplate file between users/devices
- Add descriptive name and comments to motor nameplate file

ABB motors and drives are designed to complement each other, allowing you to optimize your machine speed and reduce energy consumption.

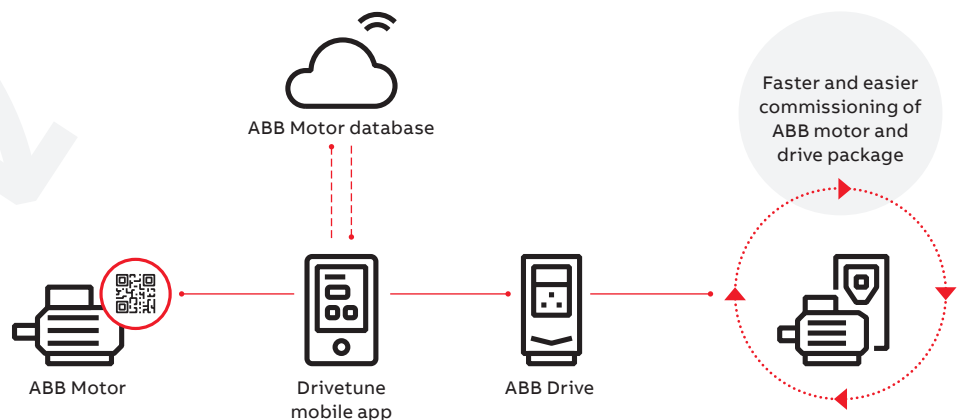

Download free from the [Apple App Store](#) or [Google Play](#).



* Drivetune does not currently support all ABB motors. We are working to expand the range of supported motors. If you receive a message saying 'data not available' when scanning a QR code, you will need to enter the data manually.

More information about the Drivetune app can be found on the [ABB website](#).

ABB ACCESS

Scan the QR code to access 24/7 self-services for ABB drives, motors and PLCs



With ABB Access, you can unlock all aspects of your drives, motors or PLCs, from one central location: the palm of your hand.

Simply scan the QR code on the ABB product to get started
 ABB Access, helps you easily find up-to-date product online data. It also provides easy access to documentation and manuals. If you happen to experience issues with your ABB product, this can be fastly and easily reported online to reach expert support from ABB.

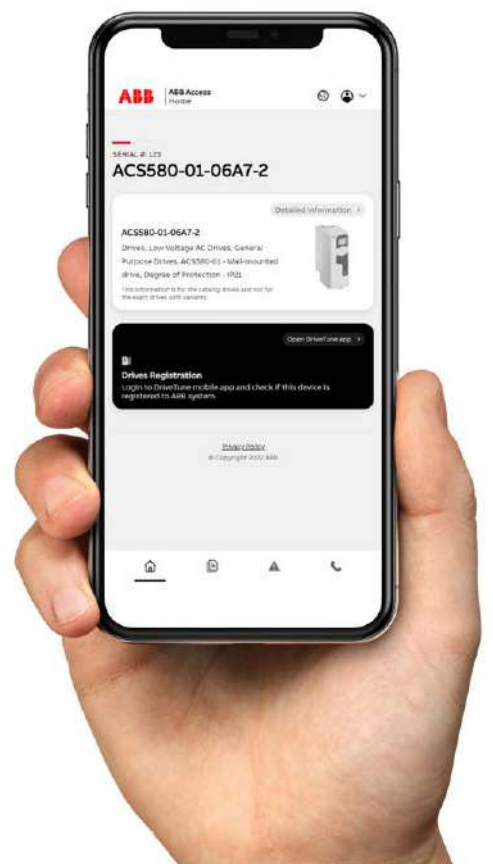
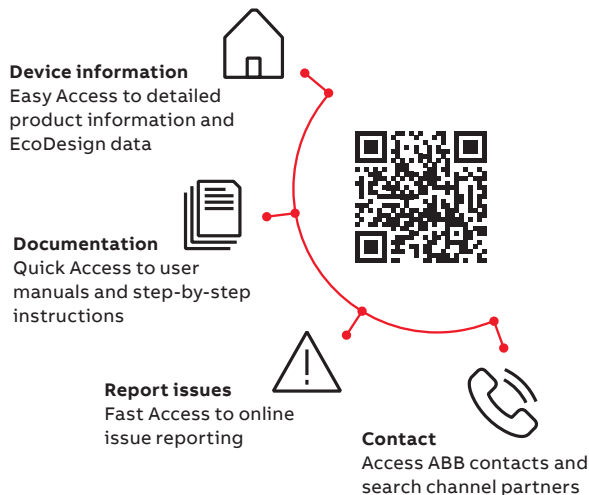

DRIVE COMPOSER 3 WITH ACS580

New generation of integration between drives and user tools



Drive Composer 3 is the latest version of our easy-to-use, reliable, and secure tool for faster commissioning, monitoring, and troubleshooting ABB all-compatible drives. The tool can also be used for optimizing drive performance.

01

More efficient than ever

- Fast, reliable connectivity options
- Quick, effortless commissioning
- Advanced features for power users

02

Easy to use

- Backward compatible and future-proof
- Easy to get started
- Faster commissioning and reduced risk

03

Reliable and secure

- Reliable remote troubleshooting
- Secure by design

Versatile PC connectivity

- Connectivity with ACS580 and other selected drives
 - USB-C connectivity on drive
 - Ethernet connectivity for tool network and fieldbus communication
- Connectivity with other drive models
 - USB connection via Assistant Control Panel (ACP)
 - Ethernet connectivity via Ethernet fieldbus adapter modules
- ACS580 supports
 - The new Drive Composer 3 as well as earlier 2.x versions
- Supported operating systems
 - Windows 10 and 11

01



02



03



Find out more and
download the tool:



ABB ABILITY™ DIGITAL POWERTRAIN

Condition monitoring for drives and rotating equipment

Accurate, real-time information about powertrain events. When you have the facts, you can make the right decisions.

ABB Ability™ Digital Powertrain

The ABB Ability Digital Powertrain enables you to remotely monitor the health and performance of entire powertrains including drives, motors and applications, such as pumps. The data collected from the connected equipment can be accessed and analyzed remotely, providing a better understanding of the health and energy efficiency of the entire process.

The service can be tailored to fit your needs

Our standard package gives you industry leading monitoring capabilities – whether you want to view the drive status through ABB's Internet portal or integrate this data with your existing monitoring systems.

The standard package includes the following services:

- Self-service condition monitoring
- Alarm Management
- Asset Health
- Team Support
- Backup Management

The standard package can be supplemented with optional services:

- Condition-Based Maintenance *)
- Offline Data Collection
- Expert Reports
- Remote Assistance
- Monitoring Service
- Plug & Play Connectivity

*) Not available for all drives



Key benefits



Solid fact-based decision making

Get the facts, and the history, to help run your operations better and more safely.



Always stay one step ahead of problems

Recognize early signs of possible failures and assess the risks before they turn into serious operational issues.



Find the root cause of process issues

Remotely access data from ABB drives built-in sensors to track the cause of problems. Get back to smooth operation quickly with data back-ups.



Remotely analyze and optimize drives

Get critical drive information anywhere anytime – even in difficult to access sites, or when a site visit is impossible.

Customers can configure powertrains and customize the digital service plan



ABB GoSelect WEB-BASED TOOL

Build the optimal solution for your application quickly and easily online

ABB GoSelect is a web-based selection and dimensioning tool for motors, drives, and PLCs. Build the optimal solution for your application and efficiently create, collect, and manage documentation and reports – all in one place.

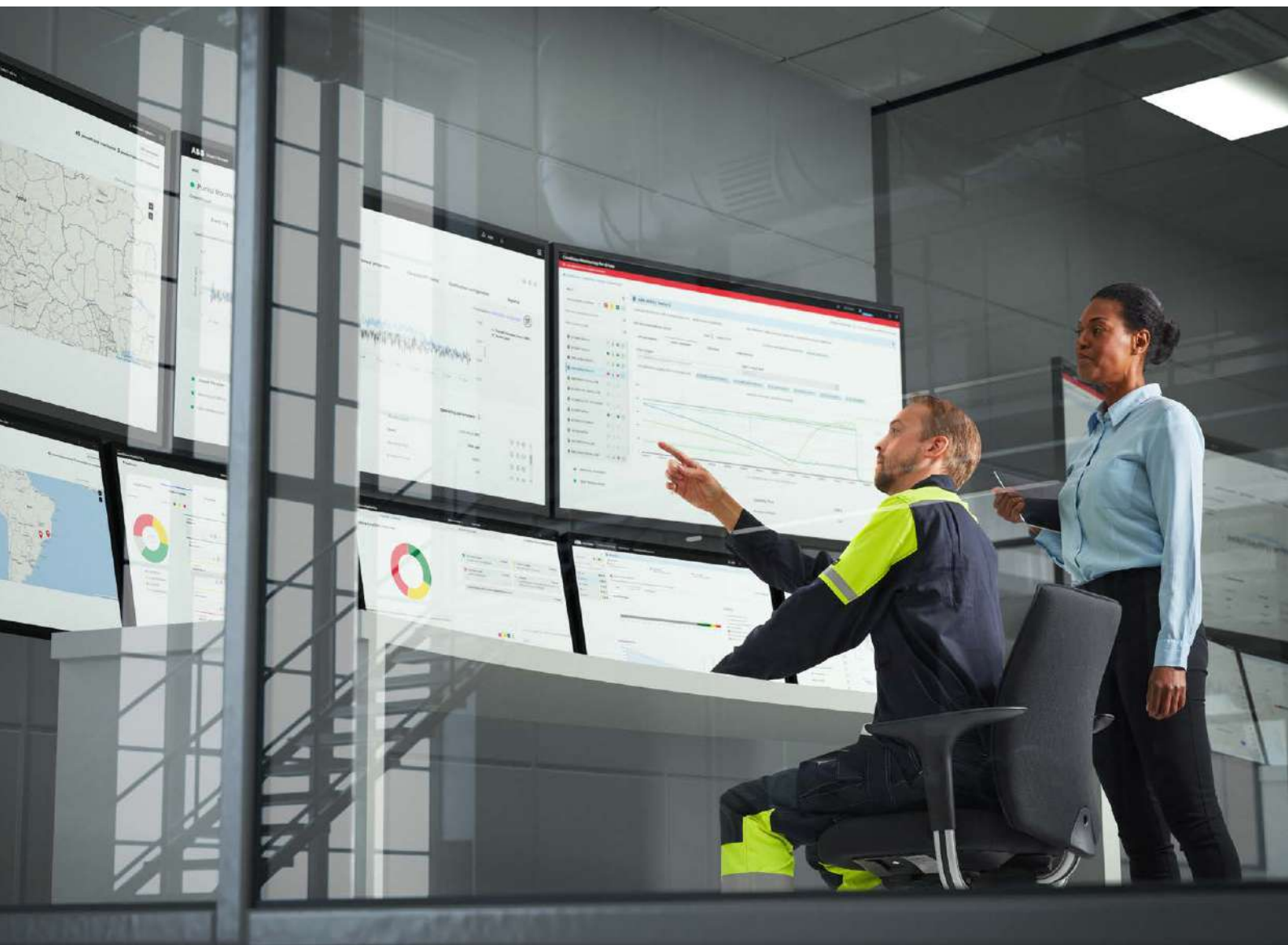
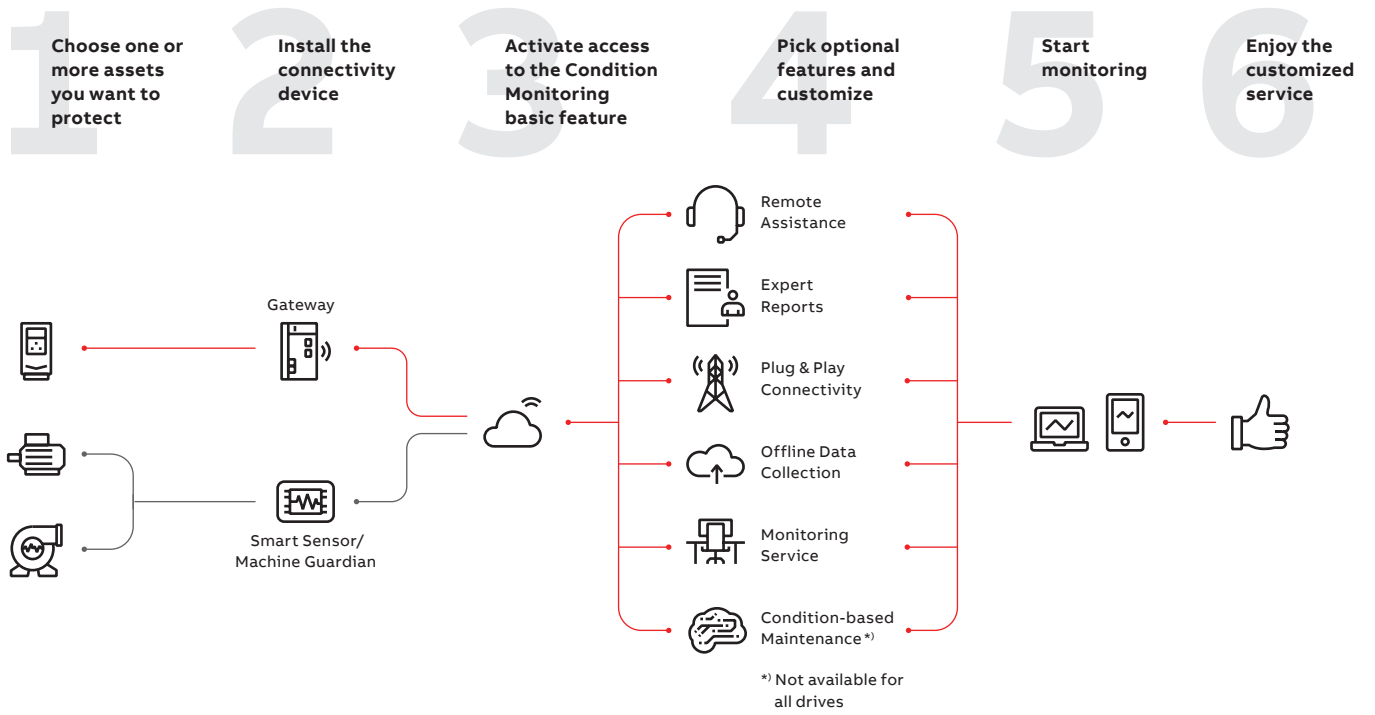
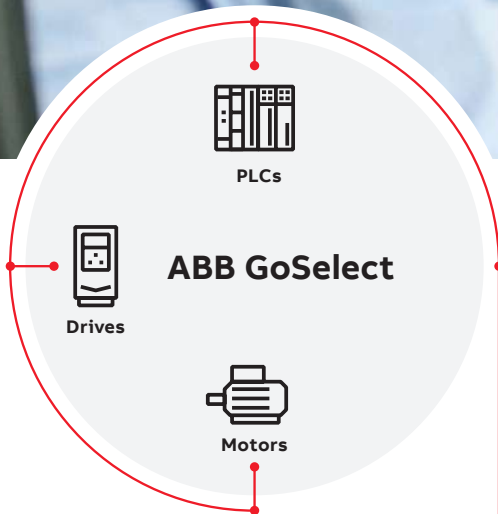

Improved productivity

ABB GoSelect's modern, intuitive interface is easy to use. You can start by following the guided selection journey to get help finding the most suitable products. If you have already identified the right product for your application, you can proceed directly to sizing. The tool can also be used to validate the selected solution directly.



All in one place

With ABB GoSelect you can select, dimension, and validate your solution – all-in-one convenient online portal, with or without logging in. No more searching and saving links or skipping between different tools. The tool eliminates the need to duplicate input data across multiple tools, bringing all your project documentation together in one place. No more wasted time.



Efficient collaboration

With ABB GoSelect, the whole team can provide their input in one place in real time. You can create different alternatives in one project to make it easy to compare your options and track the project history. No more time-consuming and confusing file exchanges via email.



For more information, see:
goselect.motion.abb.com

ABB DRIVES SOFTWARE TOOLS SUBSCRIPTIONS

Fast and flexible way to upgrade your drive experience

ABB is always looking to best serve its customers. To continue this practice ABB introduces subscriptions as a new form of purchasing ABB software solutions.



- ▶ No more large one-off payments in advance.
- ▶ Digital delivery. Immediate delivery of the subscription after the purchase via email.
- ▶ Flexible monthly subscriptions or more affordable yearly subscriptions.
- ▶ Subscription management for partners to manage subscriptions from the Subscription Management UI portal.
- ▶ Better visibility over the subscriptions. All the subscriptions in one place.
- ▶ Re-sell subscription + monetize your own support services for your end-customers.

ORDERING CODES

Subscriptions	Descriptions	MRP codes
Pro		
DCPT Subscription 1 month	Drive Composer Pro subscription for 1 month, auto-renewal	3AXD50001152413
DCPT Subscription 12 months	Drive Composer Pro subscription for 12 months, auto-renewal	3AXD50001152437
DCPT Subscription 60 months	Drive Composer Pro subscription for 60 months, auto-renewal	3AXD50001359027
Engineering¹⁾		
Engineering SW Subscription 1 month	Engineering subscription for 1 month, auto-renewal	3AXD50001152444
Engineering SW Subscription 12 months	Engineering subscription for 12 months, auto-renewal	3AXD50001152451
Engineering SW Subscription 60 months	Engineering subscription for 60 months, auto-renewal	3AXD50001359034
Support²⁾		
DCPT-01 Mobile Connect Subs 1 month	Support subscription for 1 month, auto-renewal	3AXD50001195410
DCPT-01 Mobile Connect Subs 12 months	Support subscription for 12 months, auto-renewal	3AXD50001195427
DCPT-01 Mobile Connect Subs 60 months	Support subscription for 60 months, auto-renewal	3AXD50001359041
Complete³⁾		
Complete SW Subscription 1 month	Complete subscription for 1 month, auto-renewal	3AXD50001359058
Complete SW Subscription 12 months	Complete subscription for 12 months, auto-renewal	3AXD50001359065
Complete SW Subscription 60 months	Complete subscription for 60 months, auto-renewal	3AXD50001359072

¹⁾ Engineering – subscription (combining Drive Composer Pro, Virtual Drive and Drive Application Builder into a single subscription)

²⁾ Support – subscription (combining Drive Composer Pro, Virtual Drive and Mobile Connect into a single subscription)

³⁾ Complete – subscription (combining Drive Composer Pro, Virtual Drive, Drive Application Builder and Mobile Connect into a single subscription)

For more information, see:
[new.abb.com/drives/
software-tools](https://new.abb.com/drives/software-tools)





ABB DRIVES AND OPC UA

A future proof and effective solution for data and asset management

Security, ease of use and interoperability are all features of OPC UA. ABB drives support OPC UA for data collection which means that ABB drives are equipped with OPC UA Server.

Any OPC UA Client can be connected to ABB drives and start collecting data for their purposes. By this way for example active faults, event history, active value such as power, torque and current can be accessed by OPC UA Clients securely.

This data can be used in process monitoring, asset management and for centralized event management on site, edge or in cloud via a gateway.



Benefits

- Provide a secure connection
- Server-client based connection between devices
- Event logger visibility
- A harmonized information model is provided across drive portfolio
- Utilizes single wire connection to the drive, Ethernet based protocol
- ABB or a third part OPC UA Client can fetch the data from the drive
- OPC UA Server is embedded into the PROFINET, Modbus TCP and EtherNet/IP fieldbus adapters

OPC UA is a communication protocol for interoperability and data exchange between different devices, systems and applications.

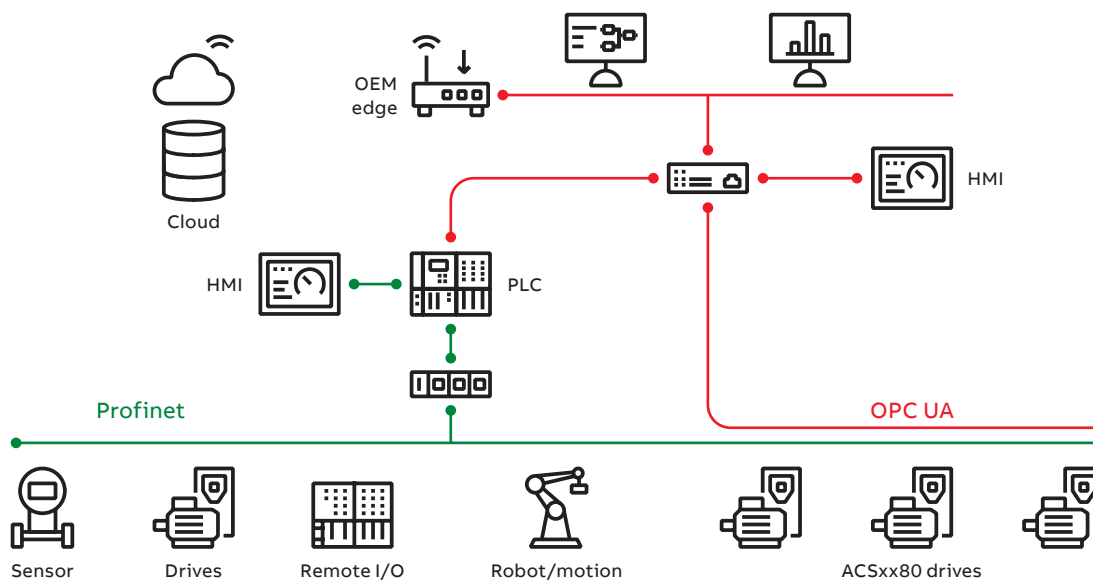

<https://new.abb.com/drives/connectivity/opc-ua-for-drives>

COMMUNICATION AND I/O OPTIONS

Fieldbus adapter modules

The ACS580 comes with Modbus RTU fieldbus interface as standard, and it is also compatible with a wide range of additional fieldbus protocols. Fieldbus communication reduces wiring costs compared to traditional hardwired input/output connections. The fieldbus options can be installed into a slot one (1).

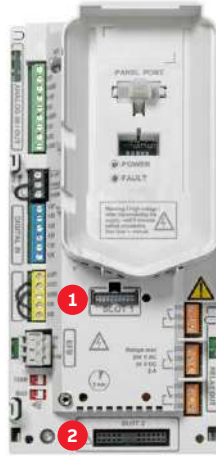

Input/output extension modules

Standard input and output can be extended by using optional analog and digital input/output extension modules. The modules are easily installed in the extension slot two (2) located on the drive.

Fieldbus options



Plus code	MRP code	Fieldbus protocol	Adapter
+K451	68469341	DeviceNet™	FDNA-01
+K454	68469325	PROFIBUS DP, DPV0/DPV1	FPBA-01
+K457	68469376	CANopen®	FCAN-01
+K458	3AUA0000031336	Modbus RTU	FSCA-01
-	3AUA0000094512	ControlNet	FCNA-01
+K469	3AUA0000072069	EtherCAT®	FECA-01
+K470	3AUA0000072120	POWERLINK	FEPL-02
+K490	3AXD50000192786	Two port Ethernet/IP	FEIP-21
+K491	3AXD50000049964	Two port Modbus/TCP	FMBT-21
+K492	3AXD50000192779	Two port PROFINET IO	FPNO-21
+Q986	3AXD50000112821	PROFIsafe safety functions module	FSPS-21
-	3AXD50001021061	CIP Safety functions module	FSCS-21



CMOD-01



CMOD-02



CAIO-01



CHDI-01



CPTC-02

Options

Plus code	MRP code	Description	Type designation
+L501	3AXD5000004420	External 24 V AC and DC 2 x RO and 1 x DO	CMOD-01
+L523	3AXD50000004418	External 24 V and isolated PTC interface	CMOD-02
+L512	3AXD50000004431	115/230 V digital input 6 x DI and 2 x RO	CHDI-01
+L537	3AXD50000033578	ATEX-certified PTC interface, Ex II (2) GD and external 24 V ^{*)}	CPTC-02
+L525	3AXD50000709243	Analogue signal extension 3 x AI and 2 x AO	CAIO-01

^{*)} For further information please see pages 48-49







^{**)} No additional analog input/output is offered

FIELDBUS ADAPTER MODULE, EMBEDDED IN ALL DRIVES

Fieldbus protocol	Features	Connector type	+Code/ MRP code/ Typecode
	<ul style="list-style-type: none"> The interface module acts as a Modbus/RTU server with support for ABB drives profiles 	Screw terminal	As standard *)
	<ul style="list-style-type: none"> Common read/write single and multiple register function codes are supported 	Screw terminal	+K458 3AUA0000031336 (FSCA-01)

*) Modbus RTU as standard only in ACS380 standard variant (ACS380-04xS), for configurable variant (ACS380-04xC) multiple fieldbus options.

THE F-SERIES FIELDBUS ADAPTER MODULES

Fieldbus protocols	Features	Connector type	+Code/ MRP code/ Typecode
	<ul style="list-style-type: none"> The interface module acts as an EtherNet/IP™ server with support for ODVA AC/DC drive and ABB drive profiles Supports both explicit messaging where each attribute of a class is set individually, and implicit messaging using input and output instances Support device-level ring (DLR) Has 2 RJ45 connections with an integrated switch OPC UA Server to improve process monitoring, data security and asset management Has Add-On Instructions available 	2 x RJ45	+K490 3AXD50000192786 (FEIP-21)
	<ul style="list-style-type: none"> PROFINET® IO is an open standard for Industrial Ethernet Used from process automation to motion control, as well as for functional-safety solutions Supports PROFIdrive and ABB drive profiles Has 2 RJ45 connections with an integrated switch S2 System redundancy Supports ring topology with Media Redundancy Protocol (MRP) OPC UA Server to improve process monitoring, data security and asset management Supports PROFIsafe with optional FSO-12/21 for ACS880 and with optional FSPS-21 for ACS380, ACS580 and ACS880 	2 x RJ45	+K492 3AXD50000192779 (FPNO-21)
	<ul style="list-style-type: none"> EtherCAT® is a real-time Ethernet master/slave fieldbus system The EtherCAT slave devices read the data addressed to them while the telegram passes through the device enabling fast real-time communication The telegrams are only delayed by a few nanoseconds Supports CiA 402 and ABB drives profiles 	2 x RJ45	+K469 3AUA0000072069 (FECA-01)
	<ul style="list-style-type: none"> CANopen® is a popular industrial communication network originally designed for motion-oriented machine control networks, such as handling systems Supports both cyclic and acyclic event driven communication. This makes it possible to reduce the bus load to a minimum and maintain short reaction times. Supports CiA 402 and ABB drive profiles 	Screw terminal D-SUB 9	+K495 (BCAN-11) 3AXD50000033816 +K457 68469376 (FCAN-01)
	<ul style="list-style-type: none"> Ethernet POWERLINK is a real-time protocol for standard Ethernet The protocol guarantees transfer of time-critical data in very short cycles with configurable response time Supports CiA 402 and ABB drives profiles 	2 x RJ45	+K470 3AUA0000072120 (FEPL-02)
	<ul style="list-style-type: none"> ControlNet™ is an open control network that meets the demands of real-time, high-throughput applications Supports controller-to-controller interlocking and real-time control of I/O, drives and valves Provides control networking in discrete and process applications including high-availability Supports ODVA AC/DC Drive and ABB drives profiles Has add-On Instructions available 	2 x 8P8C	3AUA0000094512 (FCNA-01)
	<ul style="list-style-type: none"> DeviceNet™ offers robust, efficient data handling since it is based on a Produce/Consume model Uses CAN (Controller Area Network) as the backbone technology and defines an application layer to cover a range of device profiles Supports ODVA AC/DC drive and ABB drives profiles 	Screw terminal	+K451 68469341 (FDNA-01)
	<ul style="list-style-type: none"> The interface module acts as a Modbus® TCP server with support for ABB drive profiles Common read/write single- and multiple register function codes are supported OPC UA Server to improve process monitoring, data security and asset management Has 2 RJ45 connections with an integrated switch 	2 x RJ45	+K491 3AXD50000049964 (FMBT-21)
	<ul style="list-style-type: none"> PROFIBUS® DP is the most widely used industrial network ABB drives support PROFIBUS DP-V0 and DP-V1 Supports PROFIdrive and ABB drives profiles 	D-SUB 9	+K454 68469325 (FPBA-01)

COMMISSIONING, PROGRAMMING AND CUSTOMIZATION TOOLS

Your engineering efficiency is boosted with our commissioning and programming tools, giving you the optimal solution to perform virtualization, planning, commissioning and maintenance.

Safe configuration for unpowered drives

The CCA-01 cold configuration adapter provides the access/possibility to download the software and parameters to drives without powering the drive.

Cold configurator



Users can download the software and parameters to drives without powering the drive.

MRP code	Description	Type designation
3AXD50000019865	Cold configurator adapter, packed kit	CCA-01

Drive Composer

The Drive Composer PC tool offers fast and harmonized setup, commissioning and monitoring for all-compatible drives. The free version of the tool provides startup and maintenance capabilities and gathers all drive information, such as parameter loggers, faults, backups and lists, into a support diagnostics file. Drive Composer pro provides additional features such as custom parameter windows, graphical control diagrams of the drive's configuration, and improved monitoring and diagnostics.

Drive Composer	Entry level (free)	Pro level
	Basic functionality	Entry-level features
	Parameter setting	Networked drives
	Point-to-point connection	Control diagrams
	Simple monitoring	Data logger(s)
	Supports adaptive programming	Graphical safety setup
	Adaptive programming in Demo mode	Adaptive (block) programming
	-	Multiple backup and restore
-	Drive configuration by using virtual drive	

Link/MRP codes	Description	Type designation
new.abb.com/drives/software-tools/drive-composer	Link to download free Drive Composer entry	-
9AKK105408A3415	Drive Composer entry PC tool (document)	-
3AUA0000108087	Drive Composer pro PC tool (single user license)	DCPT-01
3AUA0000145150	Drive Composer pro PC tool (10 users license)	DCPT-01
3AUA0000145151	Drive Composer pro PC tool (20 users license)	DCPT-01

Automation Builder

ABB Automation Builder is the integrated software suite for machine builders and system integrators wanting to automate their machines and systems in a productive way. Combining the tools required for configuring, programming, debugging and maintaining automation projects in a common, intuitive interface, Automation Builder addresses the largest single cost element of most of today’s industrial automation projects: software.

Automation Builder



ABB Automation Builder covers the engineering of ABB PLCs, safety PLCs, control panels, drives, motion and robots.

The common engineering tool Automation Builder is used for drive and PLC programming and configuration.

Automation Builder is available in Basic, Standard and Premium editions, fitting the needs of small projects and managing the challenges of many and large projects for OEM and system integrators.

Adaptive programming

Adaptive programming software, embedded inside the drive, is especially handy when there is a need to distribute some of the machine’s control logic to the drive. Adaptive programming brings energy savings when the drive is adjusted to control the application optimally. You can use our Drive Composer PC tool to set up the adaptive programming. The drive also offers sequence programming capabilities. Adaptive programming makes it possible to enhance the existing application control program to precisely fit users’ application needs. The program is also handy for ensuring that the drive’s electrical design is connected as it should be with working drive signals.

Adaptive programming

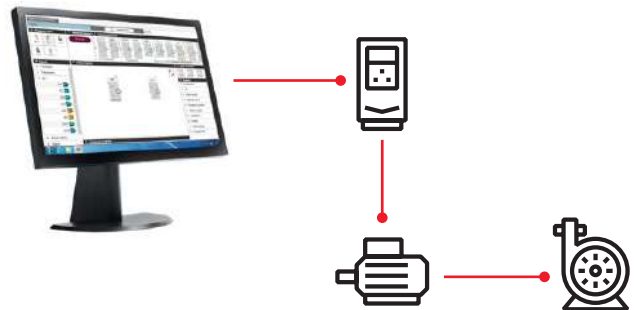

Drive manager

Drive Manager for SIMATIC (DM4S-01) is a plug-in device tool that can be easily installed, for example, in the STEP 7 and TIA Portal. It utilizes the TCI interface of the SIMATIC PLC to communicate with drives connected to PROFIBUS or a PROFINET network.

Drive Manager for SIMATIC offers several useful, ready-made features that simplify the setup of ABB low voltage drives used in combination, for example, with SIMATIC S7 PLCs including:

- Network connection over PROFIBUS and PROFINET (single point of access)
- Online and offline configuration of drives
- Monitoring of actual drive values
- Export to/import from the drive-dedicated PC tools
- Saving drive parameter settings within the SIMATIC PLC project

Drive manager

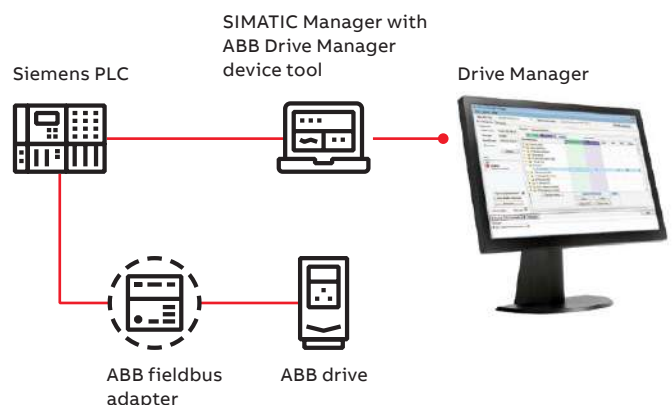

SAFETY OPTIONS

Ensure the safety of your machinery and processes with drive-based functional safety

Integrated safety

Integrated safety reduces the need for external safety components, simplifying configuration and reducing installation space. The safety functionality is a built-in feature of the ACS580, with Safe Torque Off (STO) as standard. ACS580 can also be part of PROFIsafe over PROFINET network or Common Industrial Protocol (CIP Safety) over EtherNet/IP.

The drives' functional safety is designed in accordance with EN/IEC 61800-5-2 and complies with the requirements of the European Union Machinery Directive (2006/42/EC). The safety functions are certified by TÜV Nord and comply with the highest safety performance level (SIL 3/PL e) for machinery safety. It is possible to install the safety modules also afterwards to the drive.

CIP Safety™ functions module FSCS-21 and PROFIsafe safety functions module FSPS-21

The FSCS-21 module operates through the EtherNet/IP™ communication protocol. Common Industrial Protocol (CIP Safety) over EtherNet/IP enables a single-cable solution for safety and non-safety control. It features the ready-made safe stopping functions Safe Torque Off and Safe Stop 1 (SS1-t), a time-controlled function.

The FSPS-21 module has integrated PROFIsafe, safety functions and PROFINET IO connection. The ready-made safety functions make safety configuration in the drive unnecessary. The module supports STO and SS1-t safety functions. It is used together with a safety PLC that supports PROFIsafe over PROFINET communication.

For more information about FSPS-21 PROFIsafe safety functions module and FSCS-21 CIP safety functions module see new.abb.com/drives/functional-safety



Safe Torque Off (STO)

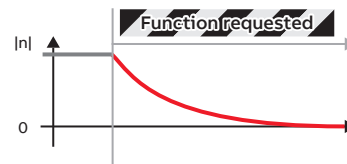

STO is the basic foundation of drive-based functional safety, as it brings a drive safely to no-torque state making the motor coast to stop. Integrated STO-function simplifies the safety circuit as external components are not needed to safely stop the application.

- **STO** is a standard safety function in all ABB drives.
- Typically used for prevention of an unexpected startup
- (EN ISO 14118) of machinery or for an emergency stop, fulfilling stop category 0 (EN 13850 / IEC 60204-1).

Safe Stop 1, time controlled (SS1-t)

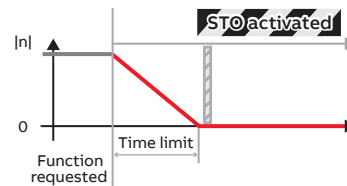

Safe Stop 1 stops the motor safely with a controlled ramp stop and stop time monitoring. SS1-t initiates the ramp stop from the drive and activates STO when speed reaches zero. If the drive is not decelerating to zero speed within the time limit, the STO function is activated. SS1-t is typically used in applications where motion must be stopped quickly and safely before switching to a no-torque state.

- **SS1-t** stops the motor safely, using a controlled ramp stop and then activates the STO function.
- **SS1-t** can be used to implement an Emergency stop, fulfilling stop category 1 (EN/IEC 60204-1).



Safety function modules

Option code	Ordering code	Module
–	3AXD50000112821	FSPS-21
–	3AXD50001021061	FSCS-21

Note: These modules are not compatible with other fieldbus option modules for ACS580 drives.

Example: SS1-t

Safety function module FSPS-21, functionality cycle

0. Drive running

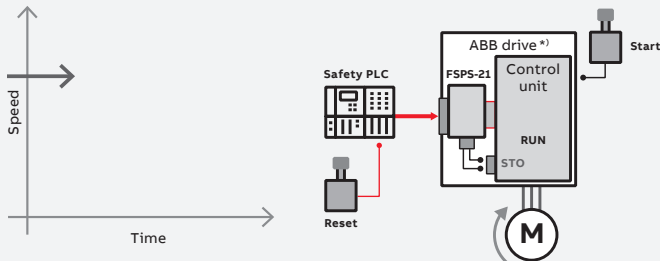

1. Safety PLC – safety function request to the FSPS-21

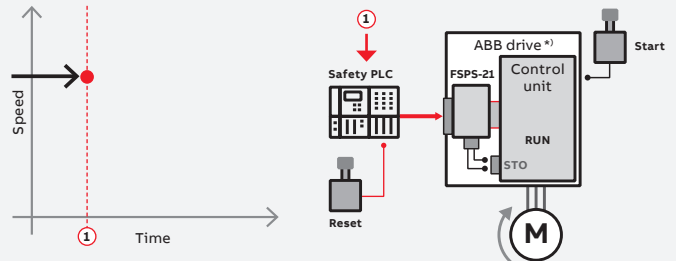

2. SS1-t, safety functions request / start of monitoring

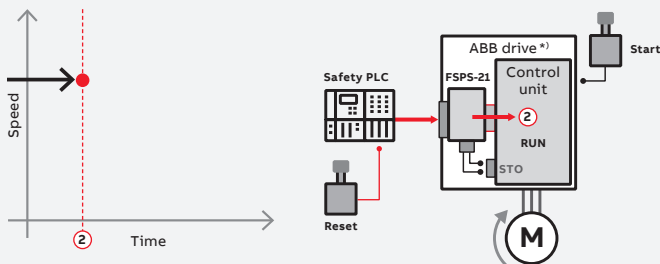

3. Transition and time monitoring of the SS1-t

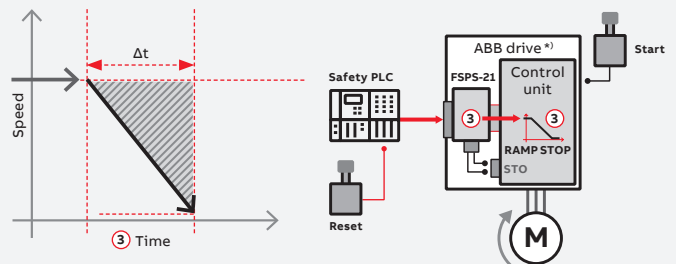

4. Zero speed or SS1-t time limit reached / STO is opened

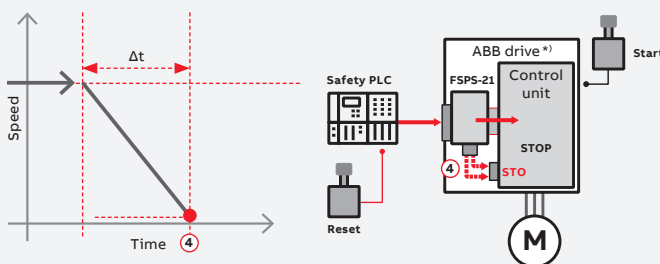

5. Safe state / STO is open

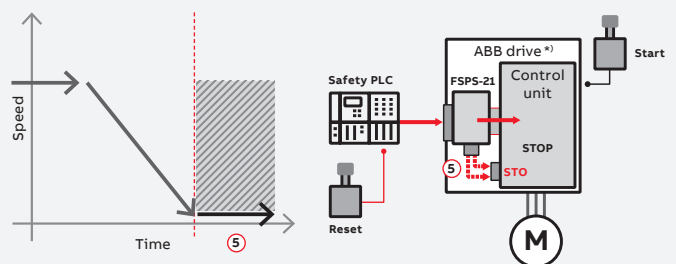

6. Safety function request removed / reset / STO is closed

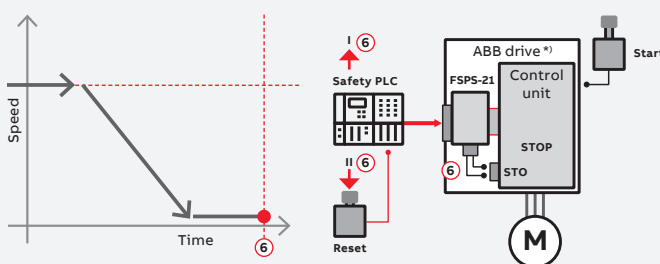

7. Start – return to normal operation

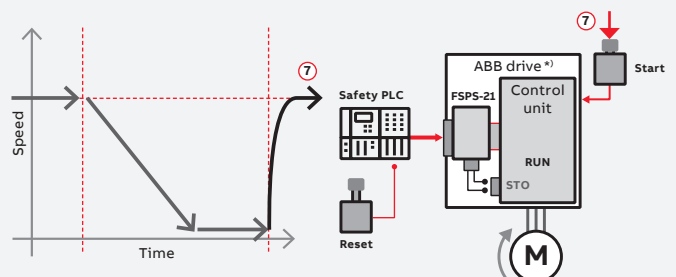

^{*)} The ABB drive can be ACS380, ACS580 or ACS880

THERMISTOR PROTECTION I/O OPTION

ATEX certified

What is a potentially explosive atmosphere and where can it be?

Explosive atmospheres occur when flammable gases, mist, vapors or dust are mixed with air, which creates a risk of explosion. A potentially explosive area is defined as a location where there is a risk of flammable mixes. These atmospheres can be found throughout industries, from **chemical, pharmaceutical and food**, to **power and wood processing**. The electrical equipment that is installed in such locations must be designed and tested to endure these conditions and guarantee a safe function.



What does ATEX mean?

The term ATEX comes from the French words "ATmosphères EXplosibles", and it is a combination of two EU directives: the Worker Protection Directive 1999/92/EC and the Product Directive 2014/34/ EU.

The ATEX Directives are designed to protect employees, the public and the environment from accidents owing to explosive atmospheres.

ATEX provides similar guidelines to the IECEx System, with a few exceptions, and with certification of protective devices (e.g. drive-integrated safety functions).



How to ensure safe operation?

With ABB's ATEX-certified offering and services, safe operation can be ensured.

Motors are directly connected to the machines in the potentially explosive atmosphere, and certain issues need to be considered when selecting a motor together with a drive. These atmospheres have a defined zone classification, and the zone defines the minimum requirements (category) the motors must comply with. The category defines the permitted motor protection types.

Potentially explosive atmosphere zones

Within industries, all potentially explosive atmospheres are required to have an area classification called Zones. Globally, a Zone system is used to classify potentially explosive areas. The Worker Protection Directive 1999/92/EC and the EU standards IEC 60079-10-x, EN 60079-10-x define these zones. In all cases, the owner of the site where the potentially explosive atmosphere exists has the responsibility to define the zones according to the requirements.

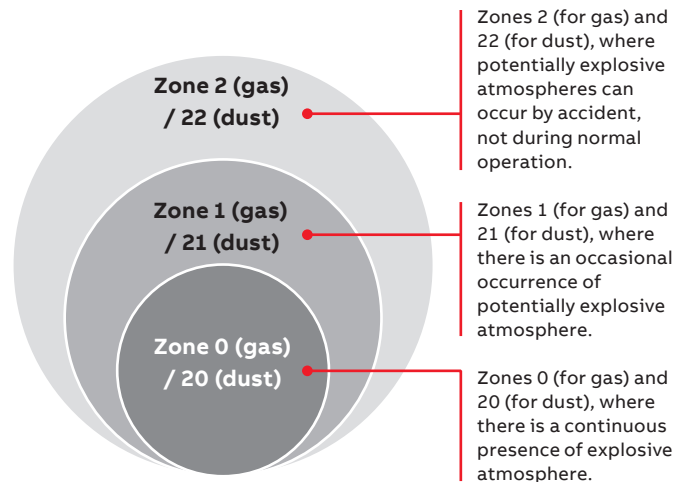

Safe temperature monitoring



The ACS580's ATEX-certified thermistor protection module, Ex II (2) GD, CPTC-02, can be integrated into the drive if the motor is operating in a potentially explosive environment. **The purpose of the safety function is to disconnect the motor from the power supply before the motor overheats and causes a risk of explosion in an ATEX environment.**

Correct dimensioning

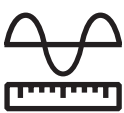

Correct dimensioning is important. **Correctly sized motors and drives reduce motor frame heating and sparks from bearing currents.** They also help to reduce energy use.

Insulation and drive filters



ABB's offering for correct insulation and filters **protects the motor** from voltage phenomena, bearing currents and motor overheating. The insulation and filters must be selected according to voltage and frame size.

Easy drive upgrades



With the drive upgrades below, the ATEX certification stays valid from the old to the new generation models. This means that there is no need for new ATEX certification during the upgrade. This saves you time and money.

ATEX certification approved – old generation model	Comparable converter upgrade	ATEX certification stays valid – new generation model
ACS550	→	ACS580

Global service and support network



ABB's global network of certified service providers are trained and experienced to help you with motors and drives for applications in explosive atmospheres.

The support network ensures that your ABB Declaration of Conformity is retained.

ABB's ATEX-certified thermistor protection module, Ex II (2) GD, CPTC-02

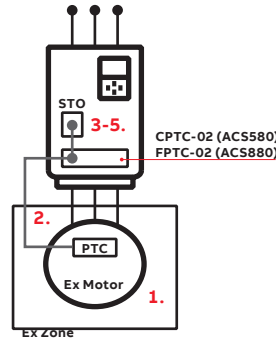

With option +L537 +Q971:

1. Motor temperature rises above the PTC sensor limit temperature.
2. The sensor resistance increases very sharply and indicates overheating to the ATEX-certified module, Ex II (2) GD.
3. The module switches the STO (Safe Torque Off) circuit off, which activates the STO function.
4. The STO function disables the control voltage in the power semiconductors of the drive output stage.
5. The drive is prevented from generating the required torque to rotate the motor.

► **The safe state is guaranteed**

Note:

The CPTC-02 module can be managed as a loose option and can also be retrofitted to the drive; in this case, to be compliant with regulations, the customer must ensure the following requirements:

- that the serial number of the drive/inverter module starts with 1, 4, 7, 8 or Y
- that the drive and option serial number is paired in a DIB (Drive Installed Base) portal
- that the included ATEX label for the SMT (Safe Motor Temperature) function is attached to the drive/inverter module to ensure the ATEX compliance of the safety circuit
- that the option module is installed in an option slot of the drive control unit and the applicable drive parameters are set
- that the PTC temperature sensors of the motor are connected to the PTC inputs of the option module.

* For further information please contact local ABB

ABB's ATEX-certified thermistor protection module

Option code	Ordering code	
+L537	3AXD50000033578	CPTC-02 ATEX-certified PTC interface, Ex II (2) GD and external 24 V (requires also option +Q971)
+Q971	-	ATEX-certified Safe Disconnection Function, Ex II (2) GD



As part of ABB's sustainability strategy, the company will provide Environmental Product Declarations for relevant products, contributing to transparent and environmentally conscious business practices.

Environmental Product Declarations (EPDs) are standardized, third party verified, documents that provide information about the environmental performance of a product throughout its life cycle. They are based on Life Cycle Assessment (LCA) data and provide information on a range of environmental impacts such as carbon footprint, energy consumption, and resource use. EPDs are part of ABB's commitment to transparency and environmental sustainability.

ABB Drives EPDs include:

1. Raw materials extraction and processing:
Information about the materials used in the product.
2. Manufacturing process:
Details about the manufacturing process, energy consumption, and emissions during production.
3. Transportation:
Information on the transportation of raw materials to the manufacturing site, and the transportation of the finished product to the end-user.
4. Installation:
Environmental impacts associated with the installation process, including energy use and emissions.
5. Use phase:
Energy consumption during the operation of the frequency converter based on efficiency its rating.

6. Maintenance:
Information about the environmental impact of maintaining and servicing the frequency converter during its operational life.
7. End of life:
Details about the recyclability of the product and the environmental impact of its disposal.

Environmental impact categories:

EPDs include information on a range of environmental impact categories, such as global warming potential, ozone depletion, acidification, eutrophication, and others.

Declaration of Global Warming Potential (GWP):

Information about the product's contribution to climate change, expressed in terms of carbon dioxide equivalent (CO₂-eq).

ABB Group EPDs follow the ISO 14025 standard.

The ABB EPD's can be found here:
[Environmental Product Declarations](#)
– [ABB Group \(global.abb\)](#)

ABB AC DRIVES COMPLY WITH THE EU ECODESIGN REQUIREMENTS

The Ecodesign regulation (EU) 2019/1781 is the legislative framework that sets minimum energy efficiency requirements for low voltage induction motors and variable speed drives. AC drives and power drive systems are classified according to their power losses. From July 2021, the minimum requirement for non-regenerative AC drives in EU is IE2.

ABB's AC drives (machinery, general, industrial and industrial specific drives) comply with the strictest requirements of the standard for energy efficiency and are classified as IE2.

Energy efficiency classes for a Complete Drive Module (CDM)

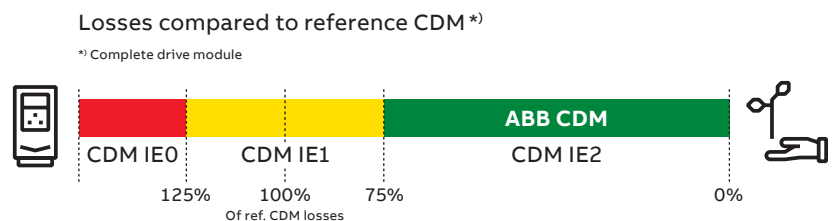

Markings on the ABB LV AC drives

Unique identifier QR code for Ecodesign information



IE class and % loss of rated apparent power 50 Hz, 400 V

IE2 (90;100) 2.3 %

Unique QR codes are located on the rating plate and/or the front of the drive.

Web-based ABB EcoDesign Tool



- Calculates absolute and relative losses and efficiency data at standard and user-defined operating points according to EU regulation 2019/1781 for complete drive module (CDM), LV motors with VSD supply, and power drive system (PDS)
- Losses and efficiency data at operating points in graphical and table format
- Printable efficiency report with possibility to customize title and additional details
- Report can be converted to PDF or CSV format and shared via email

The regulation was implemented in two steps:

Step 1: July 1, 2021

- Power range: from 0.12 to 1000 kW
- 3-phase LV AC drives with diode rectifier
- Drive manufacturers must declare power losses as a percentage of the rated apparent output power at 8 different operating points, as well as standby losses. The international IE level is given at the nominal point. Drives fulfilling the requirements are CE-marked.

Out of scope of the regulation:

- All drives without CE marking
- The following low voltage AC drives: regenerative drives, low-harmonic drives (THD < 10%), multiple AC-output drives and single-phase drives.
- Medium-voltage drives, DC drives and traction drives
- Drive cabinets that already have conformity-assessed modules

Step 2: July 1, 2023

No changes for AC drives

For more information, see: ecodesign.drivesmotors.abb.com



ACS580 DRIVES ARE COMPATIBLE

with the extensive ABB product offering



Programmable Logic Controllers PLCs

The AC500, AC500-eCo, AC500-S and AC500-XC scalable PLC ranges provide solutions for small, medium and high-end applications. Our AC500 PLC platform offers different performance levels and is the ideal choice for high availability, extreme environments, condition monitoring, motion control or safety solutions, and applications where the highest level of security is mandatory.



AC motors

ABB's low-voltage AC motors are designed to save energy, reduce operating costs and minimize unscheduled downtime. General performance motors ensure convenience, while process performance motors provide a broad set of motors for the process industries and heavy-duty applications.



Control panels

CP600-eCo, CP600, CP600-C and CP600-Pro control panels offer a wide range of features and functionalities for maximum operability. ABB control panels are distinguished by their robustness and easy usability, providing all the relevant information from production plants and machines at a single touch. Also, includes ABB's internal drive communication protocol – for seamless integration with ABB drives, enabling efficient parameter read/write access and real-time monitoring and visualization.



All-compatible drives portfolio

The all-compatible drives share the same architecture: software platform; tools; user interfaces; and options. However, there is an optimal drive, from the smallest water pump to the biggest cement kiln, and everything in between.



Safety products

ABB safety products help machine builders create production-friendly and safe work environments for operators. We deliver machine safety solutions for single machines or entire production lines. Our long experience of helping customers making solutions for demanding environments has made us experts in combining production demands with safety demands for production-friendly solutions.

BEST-IN-CLASS PERFORMANCE, ENERGY EFFICIENCY AND RELIABILITY WITH ABB MOTOR AND DRIVE PACKAGE

High Dynamic Performance (HDP) motors with ACS580 drives

ABB's HDP motors have a very high power density, which means that they provide more power to the machine applications than conventional machine motors. ABB's HDP motors are the optimal solution for high-torque machine applications such as extruders, cranes, test benches, etc.

ABB HDP motors are always used with a drive. To make full use of ABB's VSDs – including flexibility to optimize processes and control, reliability to reduce downtime, and efficiency to reduce energy use and carbon emissions – the motor's technology solution must be up to the challenge. ABB's HDP motors are designed to enable fast motion control and high maneuvering precision due to their low inertia and high overload capacity.

Induction motors and ACS580: a reliable combination

Induction motors are used throughout industry in applications that demand robust and high-enclosure motor and drive solutions. ACS580 drives fit perfectly with this type of motor by providing comprehensive functionality, yet simple operation. The drives are ideal for environments that require a high degree of protection and a small footprint. Our motors and drives provide the perfect foundation for energy efficiency while delivering capabilities such as exceeding the nominal motor speed when maximum power is needed.



Our low-voltage motors for explosive atmospheres and low-voltage industrial drives have been tested and certified to verify that when correctly dimensioned, they are safe to use in explosive atmospheres. ABB drives can also be used with non-ABB Ex motors with ATEX-certified thermistor protection. If this protection is not used, the motor and drive combination must be either type-tested or combined-tested for potentially explosive atmospheres by the customer, motor manufacturer or a third party. It is also important to verify that the motor can be used with ABB variable speed drives.

Permanent magnet motors and ACS580: smooth operation

Permanent magnet technology is used for improved motor characteristics in terms of energy efficiency and compactness. This technology is particularly suitable for low-speed control applications, as in some cases it eliminates the need to use gearboxes. The actual characteristics of different permanent magnet motors can vary considerably. Even without speed or rotor position sensors, ACS580 drives can control most types of permanent magnet motors.

IE5 Synchronous reluctance motors and ACS580: optimized energy efficiency

Combining ACS580's control technology with our Synchronous reluctance (SynRM) motors provides an IE5 motor and drive package that ensures high energy efficiency, reduces motor temperatures and provides a significant reduction in motor noise. A lower temperature results in better motor reliability and longer motor life.

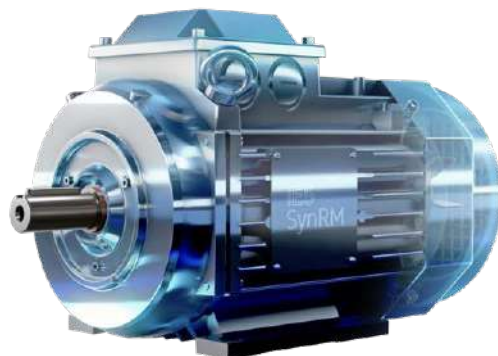

SYNCHRONOUS RELUCTANCE MOTORS

Ultimate efficiency and reliability to optimize your cost of ownership



Traditional induction motor



IE5 SynRM motor

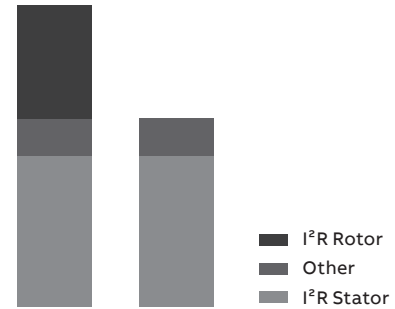

Losses IM vs. SynRM

Innovation inside

The idea is simple. Take a proven conventional stator technology and an innovative rotor design. Then combine them with an ABB machinery drive loaded with software with versatile features. Finally, optimize the whole package for applications such as compressors, conveyors, pumps, extruders, fans, and many other variable and constant torque applications.

Magnet-free design

Synchronous reluctance technology combines the performance of a permanent magnet motor with the simplicity and service-friendliness of an induction motor. The new rotor has neither magnets nor windings and suffers virtually no power losses. And because there are no magnetic forces in the rotor, maintenance is as straightforward as with induction motors.

Superior reliability to minimize the cost of not running

International Efficiency class IE5 Synchronous reluctance motors (SynRM) have very low winding temperatures, which increases the reliability and lifetime of the winding. More importantly, a cool synchronous reluctance rotor means significantly lower bearing temperatures – an important factor because bearing failures cause about 70 percent of unplanned motor outages.

Perfect for retrofits

The SynRM package is a perfect solution for motor retrofits. The IE5 SynRM is the same size as an IE3 induction motor, eliminating the need for mechanical modifications. Meanwhile, the increased efficiency will reduce the payback time of the investment.

Full motor control, down to zero speed

Many processes require accurate speed control. SynRM always runs at the reference speed with practically no error, without an encoder. Even the best slip compensation systems in an induction motor inverter will never match the precision of SynRM. Sometimes your application may require you to run your motor at slow speeds. If you are using SynRM, and your drive cannot provide the necessary torque, it may trip. ABB drives provide full control and torque down to zero speed, even without speed sensors.

For all applications

This is important if you are planning to use the motor with applications other than quadratic torque applications like pumps and fans. Our drives provide full SynRM motor control for constant torque applications such as extruders, conveyors and wire drawing machines.

Certified safety with IE5 SynRM Increased safety motors and Drives in hazardous areas

ABB is the first manufacturer in the world to offer the combination of IE5 ultra-premium efficiency and Increased safety. ABB IE5 SynRM increased safety motors for Zones 1 and 2 are fully tested and certified for explosive atmospheres with drives. Increased Safety SynRM motors provide all the benefits of SynRM motors such as ultra-premium efficiency, higher reliability and reduced maintenance.

SynRM technology	Benefit
Higher efficiency IE5	Lowest energy consumption
No rare earth metals	Environmental sustainability
Magnet-free rotor	Easy service
Lower winding and bearing temperatures	Longer lifetime, extended service intervals
Better controllability	Accurate speed and torque control
Lower noise level	Better working and living environment
Same size with IE3	Perfect for retrofits

SELECTION GUIDE

IE5 synchronous reluctance motors

This table presents performance data for IE5 SynRM motor and ACS580 drive package. Variant codes and construction details are based on the M3BP motor, protection IP55, cooling IC 411, insulation class F, temperature rise class B.

Output (kW)	Motor type ^{*)}	Product code	Motor efficiency (%)	Motor nominal current (A)	Motor nominal torque (Nm)	Motor weight (kg)	Matched ACS580-01 drive	Package efficiency ^{**)} IES at nominal point (Pn) (%)	PDS ^{***)} IES2 efficiency class low limit (%)	Package efficiency above IES2 efficiency class low limit (%)	Drive frame size
3000 RPM / 100 Hz			400 V network								
5.5	M3AL132SMA4	3GAL132217-C	92.8	12.1	17.5	41	ACS580-01-12A7-4	89.6	82.5	8.6	R1
7.5	M3AL132SMB4	3GAL132227-C	93.1	16.5	23.9	41	ACS580-01-018A-4	90.4	83.9	7.7	R2
11	M3AL132SMC4	3GAL132237-C	94	24.5	35	47	ACS580-01-026A-4	90.9	85.3	6.6	R2
11	M3BL160MLA4	3GBL162417-C	93.6	25.6	35	133	ACS580-01-033A-4	90.4	85.3	6	R3
15	M3AL132SMD4	3GAL132247-C	94.1	32.9	47.8	47	ACS580-01-039A-4	91.2	86.2	5.8	R3
15	M3BL160MLB4	3GBL162427-C	95.1	34.6	48	133	ACS580-01-039A-4	92.2	86.2	7	R3
18.5	M3BL160MLC4	3GBL162437-C	94.6	43.3	59	133	ACS580-01-046A-4	91.3	86.9	5.1	R3
22	M3BL180MLB4	3GBL182427-C	95.5	50.5	70	190	ACS580-01-062A-4	92.5	87.3	6	R4
30	M3BL200MLC4	3GBL202437-C	95.9	68.9	95.6	277	ACS580-01-073A-4	92.5	88.1	5	R4
37	M3BL200MLD4	3GBL202447-C	96.1	84.5	118	277	ACS580-01-089A-4	93.5	88.6	5.5	R4
45	M3BL225SMB4	3GBL222227-C	96.1	99.8	143	330	ACS580-01-106A-4	93.5	89	5.1	R5
55	M3BL250SMA4	3GBL252217-C	96.4	123	175	396	ACS580-01-145A-4	93.6	89.4	4.7	R6
75	M3BL250SMB4	3GBL252227-C	96.5	167	239	396	ACS580-01-169A-4	93.8	90	4.2	R7
90	M3BL250SMC4	3GBL252237-C	96.4	198	286	454	ACS580-01-206A-4	93.4	90.2	3.5	R7
1500 RPM / 50 Hz											
5.5	M3AL132SMA4	3GAL132213-C	93.7	11.7	35	63	ACS580-01-12A7-4	90.4	82.5	9.6	R1
7.5	M3AL132SMB4	3GAL132223-C	93.7	15.7	47.8	63	ACS580-01-018A-4	91	83.9	8.5	R2
11	M3AL132SMC4	3GAL132233-C	94.2	23.8	70	69	ACS580-01-026A-4	90.9	85.3	6.6	R2
11	M3BL160MLA4	3GBL162413-C	94	24.2	70	160	ACS580-01-026A-4	90.8	85.3	6.4	R2
15	M3BL160MLB4	3GBL162423-C	94.9	31.3	95	177	ACS580-01-039A-4	91.9	86.2	6.6	R3
18.5	M3BL180MLB4	3GBL182423-C	95	42.8	118	222	ACS580-01-046A-4	91.4	86.9	5.2	R3
22	M3BL180MLC4	3GBL182433-C	95.4	49.4	140	222	ACS580-01-062A-4	92.1	87.3	5.5	R4
30	M3BL200MLB4	3GBL202423-C	95.9	65	191	304	ACS580-01-073A-4	92.5	88.1	5	R4
37	M3BL225SMB4	3GBL222223-C	96.3	79.3	236	385	ACS580-01-089A-4	93.8	88.6	5.9	R4
45	M3BL225SMC4	3GBL222233-C	96.3	98.5	286	350	ACS580-01-106A-4	93.5	89	5.1	R5
55	M3BL250SMB4	3GBL252223-C	96.5	117	350	454	ACS580-01-145A-4	93.5	89.4	4.6	R6
75	M3BL280SMA4	3GBL282213-C	96.2	166	478	639	ACS580-01-169A-4	93.6	90	4	R7
90	M3BL280SMB4	3GBL282223-C	96.5	199	573	639	ACS580-01-206A-4	93.5	90.2	3.7	R7
110	M3BL280SMC4	3GBL282233-C	96.7	241	699	697	ACS580-01-246A-4	93.9	90.5	3.8	R8
110	M3BL315SMA4	3GBL312213-C	96.8	243	702	873	ACS580-01-246A-4	94.1	90.5	4	R8
132	M3BL315SMB4	3GBL312223-C	96.8	290	842	925	ACS580-01-293A-4	93.8	90.7	3.4	R8
160	M3BL315SMC4	3GBL312233-C	97.1	343	1018	965	ACS580-01-363A-4	94.2	90.9	3.6	R9
200	M3BL315MLA4	3GBL312413-C	97.2	428	1272	1116	ACS580-01-430A-4	94.1	91.1	3.3	R9
250	M3BL315LKA4	3GBL312813-C	97.1	552	1591	1357	ACS580-04-585A-4	94.6	91.2	3.7	R10
315	M3BL315LKC4	3GBL312833-C	97.2	662	2006	1533	ACS580-04-725A-4	94.9	91.2	4.1	R11

^{*)} Motor type M3AL = aluminum motor frame
Motor type M3BL = cast iron motor frame

^{**)} Calculated package efficiency values for ACS580-01
^{***)} PDS = Power Drive System

Output	Motor type ^{*)}	Product code	Motor efficiency	Motor nominal current	Motor nominal torque	Motor weight	Matched ACS580-01 drive	Package efficiency ^{**)} IES at nominal point (Pn)	PDS ^{***)} IES2 efficiency class low limit	Package efficiency above IES2 efficiency class low limit	Drive frame size
(kW)			(%)	(A)	(Nm)	(kg)		(%)	(%)	(%)	
1000 RPM / 33.3 Hz						400 V network					
7.5	M3BL160MLA4	3GBL162412-C	93.1	16.5	72	160	ACS580-01-018A-4	90.2	83.9	7.5	R2
11	M3BL160MLB4	3GBL162422-C	93.7	24.1	105	177	ACS580-01-026A-4	90.4	85.3	6	R2
15	M3BL180MLC4	3GBL182432-C	94.2	34.1	143	216	ACS580-01-039A-4	90.9	86.2	5.5	R3
18.5	M3BL200MLA4	3GBL202412-C	95.2	39.9	177	304	ACS580-01-046A-4	91.9	86.9	5.8	R3
22	M3BL200MLB4	3GBL202422-C	95	47	210	304	ACS580-01-062A-4	91.9	87.3	5.3	R4
30	M3BL225SMB4	3GBL222222-C	95.5	64.7	287	348	ACS580-01-073A-4	92.1	88.1	4.5	R4
37	M3BL250SMA4	3GBL252212-C	95.6	80.5	353	428	ACS580-01-089A-4	93.3	88.6	5.3	R4
45	M3BL280SMA4	3GBL282212-C	96.2	98.6	430	639	ACS580-01-106A-4	93.5	89	5.1	R5
55	M3BL280SMB4	3GBL282222-C	96	119	526	639	ACS580-01-145A-4	93	89.4	4	R6
75	M3BL280SMC4	3GBL282232-C	96.2	160	715	697	ACS580-01-169A-4	93.6	90	4	R7
75	M3BL315SMA4	3GBL312212-C	96.5	164	717	873	ACS580-01-169A-4	93.8	90	4.2	R7
90	M3BL315SMB4	3GBL312222-C	96.8	199	859	925	ACS580-01-206A-4	93.7	90.2	3.9	R7
110	M3BL315SMC4	3GBL312232-C	96.8	241	1051	965	ACS580-01-246A-4	93.9	90.5	3.8	R8
132	M3BL315MLA4	3GBL312412-C	97.1	278	1261	1116	ACS580-01-293A-4	94	90.7	3.6	R8
160	M3BL315LKA4	3GBL312812-C	97.1	341	1527	1357	ACS580-01-363A-4	94.2	90.9	3.6	R9
200	M3BL315LKC4	3GBL312832-C	97.3	416	1910	1533	ACS580-01-430A-4	94.3	91.1	3.5	R9

^{*)} Motor type M3AL = aluminum motor frame
Motor type M3BL = cast iron motor frame

^{**)} Calculated package efficiency values for ACS580-01

^{***)} PDS = Power Drive System

SUMMARY OF DRIVE ORDERING CODES

ACS580-01

The type designation tells you the specifications and configuration of the drive.

The table shows the primary drive variants.

Sample type code: ACS580-01-12A7-4+XXXX

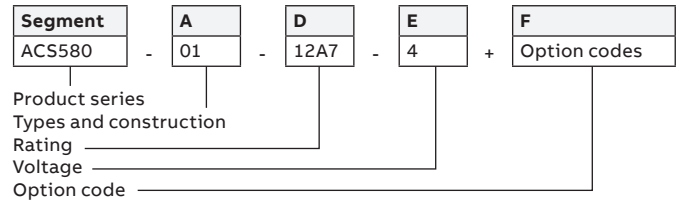

Basic codes

Segment	Option	Description
A	Construction	01 = when no options are selected: wall-mounted drive, IP21 (UL Type 1), ACS-AP-S control panel with a USB port, embedded Modbus RTU, choke, internal EMC C2 filter, Safe Torque Off, braking chopper in frames R1, R2, R3, coated boards, cable lead through entry from the bottom, cable box or conduit plate with cable entries, quick installation and start-up guide (multilingual)
D	Current rating	Refer to the rating table
E	Voltage rating	4 = 400/480 V (380...480 V) 2 = 230 V (200...240 V)

Option codes

Segment	Option	Code	Description
F	Control panel and panel options	+J400	ACS-AP-S Assistant control panel (as standard)
		+0J400	No control panel
		+J404	ACS-BP-S Basic control panel (replaces +J400 ACS-AP-S Assistant control panel)
		+J424	CDUM-01 Blank control panel cover (no control panel)
		+J425	ACS-AP-I Assistant control panel (replaces +J400 ACS-AP-S Assistant control panel)
		+J429	ACS-AP-W Assistant control panel with a Bluetooth interface (replaces +J400 ACS-AP-S Assistant control panel)
	I/O (one slot available for I/O options)	+L501	CMOD-01 External 24 V AC/DC and digital I/O extension (2×RO and 1×DO)
		+L512	CHDI-01 115/230 V Digital input extension (6×DI and 2×RO)
		+L523	CMOD-02 External 24 V AC/DC and isolated PTC interface
		+L525	CAIO-01 analogue signal extension (3 x AI and 2 x AO)
		+L537	CPTC-02 ATEX-certified PTC interface, Ex II (2) GD and external 24 V. Requires also option +Q971.
		Safety	+Q971
	+Q986		PROFIsafe safety functions module (FSPS-21)
	-		3AXD50001021061 CIP Safety functions module (FSCS-21)
	Fieldbus	+K451	DeviceNet™ (FDNA-01)
		+K454	PROFIBUS® DP (FPBA-01)
+K457		CANopen® (FCAN-01)	
-		ControlNet™ (FCNA-01)	
+K469		EtherCAT® (FECA-01)	
+K470		Ethernet POWERLINK (FEPL-01)	
+K475		2-port Ethernet (EtherNet/IP™, Modbus®/TCP, PROFINET®)	
+K490		EtherNet/IP™ (FEIP-21)	
+K491		Modbus®/TCP (FMBT-21)	
+K492		PROFINET® IO (FPNO-21)	
IP enclosure	+B056	IP55 (UL Type 12). Factory option, retrofit not possible.	
Construction	+C135	Flange mounting kit. (Only available for 400V IP21 drives)	
	+H358	Cable conduit plate, blank	
	+P944	Drive without cable entry box. Version for cabinet mounting (R5-R9).	
	+F278	Main switch disconnecter (R1-R5)	
	+E223	EMC filter, category C1 for earthed network (R1-R5)	
	+F316	Main switch and EMC filter, category C1 for earthed network (R1-R5)	
	Complementary options	+P931	Extended warranty up to 36 months
+P932		Extended warranty up to 60 months	
+P952		European Union Country of origin	

ACS580-04

The type designation tells you the specifications and configuration of the drive.

The table shows the primary drive variants.

Sample type code: ACS580-04-505A-4+XXXX

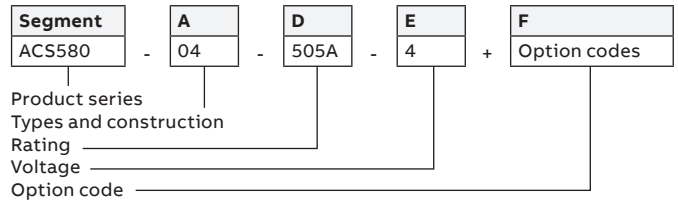

Basic codes

Segment	Option	Description
A	Construction	04 = when no options are selected: drive module, IP00 (UL Type open), bookshelf mounting with pedestal, integrated control unit (inside the drive module), ACS-AP-S control panel with a USB port, embedded Modbus RTU, build-in choke, extraction/installation ramp, full-size output cable connection terminals, common mode filter (+E208), DPMP-03 mounting platform, internal EMC C3 filter TN (grounded) and IT (ungrounded) systems (+E210), no DC connection busbars, Safe Torque Off, coated boards, quick installation and start-up guide (multilingual)
D	Current rating	Refer to the rating table
E	Voltage rating	4 = 400/480 V (380...480 V)

Option codes

Segment	Option	Code	Description
F	Control panel and panel options	+J400	ACS-AP-S Assistant control panel (as standard)
		+OJ400	No control panel
		+J425	ACS-AP-I Assistant control panel (replaces +J400 ACS-AP-S Assistant control panel)
		+J404	ACS-BP-S Basic control panel (replaces +J400 ACS-AP-S Assistant control panel)
		+J429	ACS-AP-W Assistant control panel with a Bluetooth interface (replaces +J400 ACS-AP-S Assistant control panel)
	I/O (one slot available for I/O options) (L501, L523 and L512 available as retrofit options)	+L501	CMOD-01 External 24 V AC/DC and digital I/O extension (2×RO and 1×DO)
		+L512	CHDI-01 115/230 V Digital input extension (6×DI and 2×RO)
		+L523	CMOD-02 External 24 V AC/DC and isolated PTC interface
		+L525	CAIO-01 analogue signal extension (3 x AI and 2 x AO)
		+L537	CPTC-02 ATEX-certified PTC interface, Ex II (2) GD and external 24 V. Requires also option +Q971.
Safety	+Q971	ATEX-certified Safe Disconnection Function, Ex II (2) GD / CPTC-02 (+Q971 option sold only together with +L537 option)	
	+Q986	PROFIsafe safety functions module (FSPS-21)	
	-	3AXD50001021061 CIP Safety functions module (FSCS-21)	
Fieldbus (One fieldbus adapter supported. Fieldbus adapters available as loose options for retrofit.)	+K451	DeviceNet™ (FDNA-01)	
	+K454	PROFIBUS® DP (FPBA-01)	
	+K457	CANopen® (FCAN-01)	
	-	ControlNet™ (FCNA-01)	
	+K469	EtherCAT® (FECA-01)	
	+K470	Ethernet POWERLINK (FEPL-01)	
	+K475	2-port Ethernet (EtherNet/IP™, Modbus®/TCP, PROFINET®)	
	+K490	EtherNet/IP™ (FEIP-21)	
	+K491	Modbus®/TCP (FMBT-21)	
	+K492	PROFINET® IO (FPNO-21)	
IP enclosure	+B051	IP20 Finger safe	
Construction	+J410	Control panel door mounting kit (+ J410 DPMP-03, delivered as a standard)	
	+H381	Full power cabling panels to be attached to a cabinet, the drive module can be pulled out from the cabinet without disconnecting the power cables	
	+H370	Full-size input terminals	
	+P906	Remote control board	
	+OH371	No full size output terminals	
	+OH534	No pedestal	
	+OP919	No cabinet installation ramp	
	Filters	+E202	EMC/RFI-filter, C2, 1 st environment (earthened networks)
+E210		EMC/RFI-filter, C3 (delivered as standard)	
+E208		Common mode filter (delivered as standard)	
Resistor braking	+D150	Brake chopper	
Complementary options	+P931	Extended warranty up to 36 months	
	+P932	Extended warranty up to 60 months	
	+P952	European Union Country of origin	

ACS580-07

The type designation tells you the specifications and configuration of the drive.

The table shows the primary drive variants.

Sample type code: ACS580-07-145A-4+XXXX

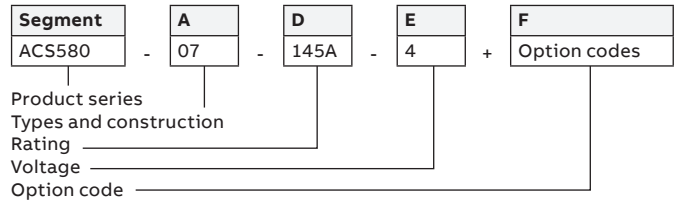

Basic codes

Segment	Option	Description
A	Construction	07 = when no options are selected: cabinet-installed drive, IP21 (UL Type 1), ACS-AP-S control panel with a USB port, embedded Modbus RTU, main switch, AC fuses, internal EMC C3 filter (TN grounded), common mode filter in frames R10 and R11, Safe Torque Off, bottom entry and exit of cables, USB memory containing all manuals.
D	Current rating	Refer to the rating table
E	Voltage rating	4 = 380...480 V

Option codes

Segment	Option	Code	Description	
F	Control panel and panel options	+J400	ACS-AP-W Assistant control panel	
	I/O (one slot available for I/O options)		+L501	External 24 V DC/AC and Digital I/O extension (2xRO and 1xDO)
			+L504	Additional I/O-Terminal Block
			+L512	115/230V Digital input (6xDI and 2xRO)
			+L523	External 24 V and isolated PTC interface
			+L525	CAIO-01 analogue signal extension (3 x AI and 2 x AO)
	Options for cabinet		+L537	ATEX-certified thermistor protection module, Ex II (2) GD (requires ATEX-certified Safe Disconnection Function, Ex II (2) GD, add +Q971 to code)
			+L506 *)	Pt100 relay 1 pc (non Ex compatible)
			+2L506 *)	Pt100 relay 2 psc (non Ex compatible)
			+3L506 *)	t100 relay 3 pcs (non Ex compatible)
			+5L506 *)	Pt100 relay 5 pcs (non Ex compatible)
			+G307 *)	Terminal for external AC control voltage
			+H537 *)	Cable lead through entry (European)
Safety		+Q971	ATEX-certified Safe Disconnection Function, Ex II (2) GD (+Q971 option sold only together with +L537 option. Not available with +Q951)	
		+Q951	Safety option of emergency stop where Main breaker is opened during emergency	
		+Q963	Safety option of emergency stop where main breaker is not opened during emergency	
		+Q986	PROFIsafe safety functions module (FSPS-21)	
Fieldbus (One fieldbus adapter supported. Note: Embedded fieldbus interface can't be used at the same time with fieldbus adapter. Fieldbus adapters available as loose options for retrofit.)		+K451	DeviceNet™ (FDNA-01)	
		+K454	PROFIBUS® DP (FPBA-01)	
		+K457	CANopen® (FCAN-01)	
		-	ControlNet™ (FCNA-01)	
		+K469	EtherCAT® (FECA-01)	
		+K470	Ethernet POWERLINK (FEPL-01)	
		+K475	2-port Ethernet (EtherNet/IP™, Modbus®/TCP, PROFINET®)	
		+K490	EtherNet/IP™ (FEIP-21)	
ABB Ability™ Condiion Monitoring for drives		+K491	Modbus®/TCP (FMBT-21)	
		+K492	PROFINET® IO (FPNO-21)	
		+K496	NETA-21 Wired remote monitoring system	
IP enclose		+K497	Connectivity for wireless remote monitoring (Not released, requires +K496)	
		+B054	IP42 enclosure class (Type 1 in case of UL certification)	
Construction		+B055	IP54 enclosure class (Type 12 in case of UL certification)	
		+C129	Cabinet drive is UL listed	
Filters		+E205	Du/dt filter	
		+E208	Common mode filter (as a default for R10-R11)	
		+F250	Line contactor	
		+F289	Molded case circuit breaker (UL listed, requires C129 option)	

Basic codes				
Segment	Option	Code	Description	
F	Cabling	+H351	Top entry (additional channel for frames R4-R9, +125 mm the drive cabinet width) Top entry through roof (frames R10-R11)	
		+H353	Top exit (additional channel for frames R4-R9, +125mm the drive cabinet width) Top exit (frames R10-R11) – additional 150 mm channel	
		+H358	Cable conduit entry (Default in US, anywhere else specify in order)	
		+C164	Plinth 100 mm (separate in package)	
		+C179	Plinth 200 mm (separate in package)	
		Cabinet options	+C128	Cooling air intake through bottom of cabinet
	+C130		Channeled air outlet	
	+C196		Empty cabinet 400 mm on right side (not available with +H351 and/or +H353 for frames R4-R9)	
	+C197		Empty cabinet 600 mm on right side (not available with +H351 and/or +H353 for frames R4-R9)	
	+C198		Empty cabinet 800 mm on right side (not available with +H351 and/or +H353 for frames R4-R9)	
	+C199		Empty cabinet 400 mm on left side (not available with +H351 and/or +H353 for frames R10-R11)	
	+C200		Empty cabinet 600 mm on left side (not available with +H351 and/or +H353 for frames R10-R11)	
	+C201		Empty cabinet 800 mm on left side (not available with +H351 and/or +H353 for frames R10-R11)	
	+G300		Cabinet heater (External supply)	
	+G313		Output for motor heater	
	+G327		Ready Pilot light, white	
	+G307		Terminals for external control voltage	
	+G328		Run Pilot light, green	
	+G329		Fault Pilot light, red	
	Starter for auxiliary motor fan		+M600	1...1.6 A; 1PC-s, dimensioned by fan size, Includes protective devices
			+M601	1.6...2.5 A; 1PC-s, dimensioned by fan size, Includes protective devices
			+M602	2.5...4 A; 1PC-s, dimensioned by fan size, Includes protective devices
		+M603	4...6.3 A; 1PC-s, dimensioned by fan size, Includes protective devices	
		+M604	6.3...10 A; 1PC-s, dimensioned by fan size, Includes protective devices	
		+M605	10...16 A; 1PC-s, dimensioned by fan size, Includes protective devices	
	Complementary options	+P931	Extended warranty up to 36 months	
		+P932	Extended warranty up to 60 months	
	Specialities	+P912	Seaworthy Packing (R10, R11: High Cube (HC) container required for reshipping)	
		+P929	Container Packing (R10, R11: High Cube (HC) container required for reshipping)	

*) Notes:

- Options +L506, +2L506, +3L506, +5L506 are required to have built-in relays into the cabinet. This relay can acquire the Pt100 signal from the motors and generate a safe voltage that can be applied to the control board where the customer can generate an external event; only one of this option can be selected at the time.
- Option +G307 is making available terminals for external AC control voltage.
- European cable lead entry is included in the standard configuration.
Option +H357 can be selected only when option +C129 has been pre-selected; +H357 is not compatible with option with +H358.
- Only one "Starters for auxiliary fan" option can be selected at the time.

ABB MOTION SERVICES

ABB Motion Services helps customers around the globe by maximizing uptime, extending product life cycle, and enhancing the performance and energy efficiency of electrical motion solutions. We enable innovation and success through digitalization by securely connecting and monitoring our customers' motors and drives, increasing operational uptime, and improving efficiency. We make the difference for our customers and partners every day by keeping their operations running profitably, safely and reliably.



A LIFETIME OF PEAK PERFORMANCE

You're in control of every life-cycle phase of your drives. At the heart of drive services is a four-phase product life-cycle management model. This model defines the services recommended and available throughout drives lifespan.

—
Now it's easy for you to see the exact service and maintenance available for your drives.

ABB drives life-cycle phases explained:

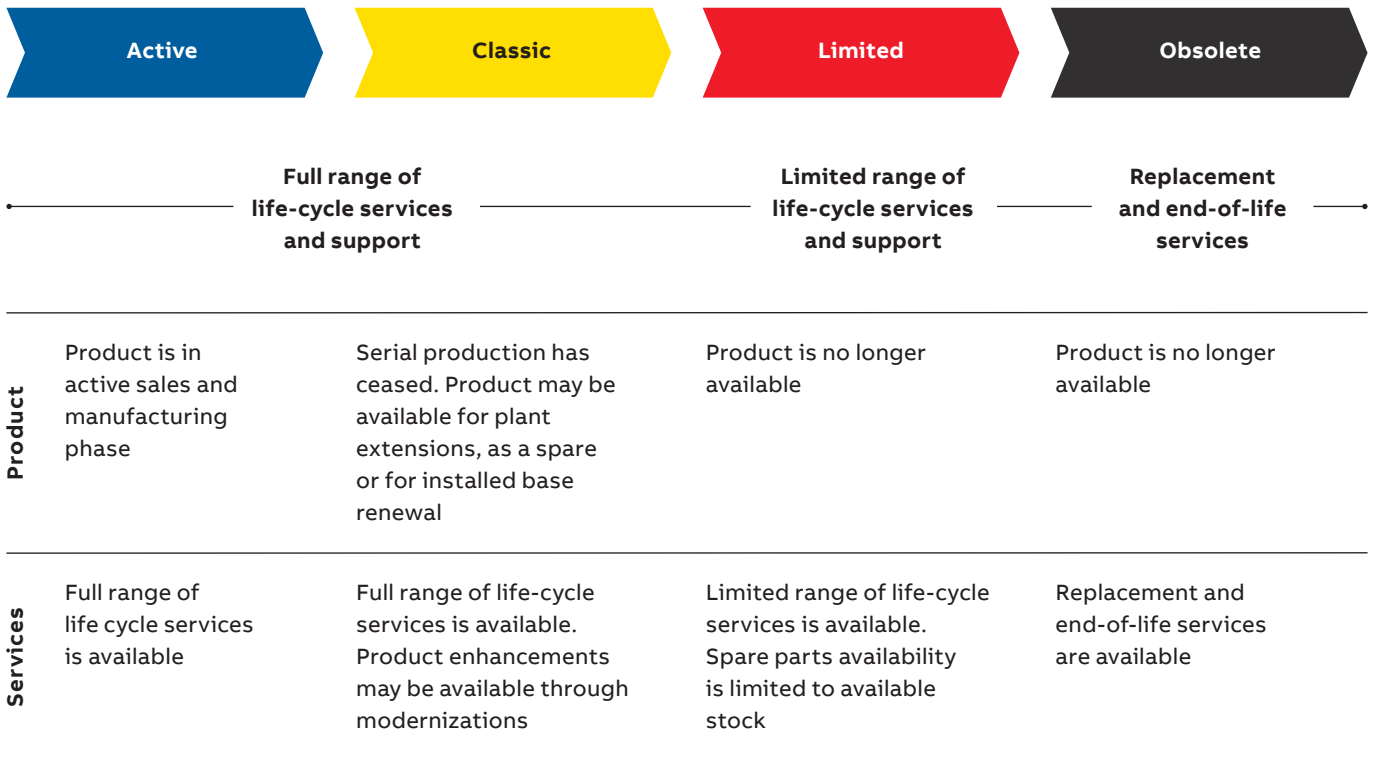

Keeping you informed

We notify you every step of the way using life-cycle status statements and announcements.

The benefit for you is clear information about the status of your drives and the exact services available. It helps you plan the preferred service actions ahead of time and make sure that continuous support is always available.

Step 1

Life-cycle Status Announcement

Provides early information about the upcoming life-cycle phase change and how it affects the availability of services.

Step 2

Life-cycle Status Statement

Provides information about the drive's current life-cycle status, the availability of product and services, the life-cycle plan, and recommended actions.



—
For more information, please contact
your local ABB representative or visit

- new.abb.com/drives/ACS580
- new.abb.com/drives/general-purpose
- new.abb.com/drives
- new.abb.com/drives/drivespartners
- new.abb.com/motors-generators

ACS580 technical animation video



Video playlist:
ACS580 how-to videos

